



BRIEF INTRODUCTION

公司简介

We are a group of deep and professional elevator practitioners. Decades of experience tell us that there are still many problems of elevator industry have to be settled urgently. Such as development of customized designs, shortage of local elevator engineers, elevator installation control, nonstandard of aftersales service operation, and outdated elevator agents & partners cooperation mode, etc.

Most of elevator suppliers not take them seriously, they just provide same normal elevators and services, and they think business is over when elevator sold out. Such debated business way unable to meet local service needs for clients from oversea market.

Therefore, we build our company, LG elevator which is determined to focus on local service while providing customized elevators, we will try to support and cultivate local agents and partners, to raise elevator business cooperation to be a new higher level.

We are a young company, but our staffs are all much professional deeply in elevator industry. Such as workshop workers who have 5-15 years proficient experience in operating, technical engineers who already worked for 20-30 years practices, sales who finally be qualified here already much trained, seriously selected, strictly valued. We believe our team can provide you the most attentive service to you.

We always think that: Firstly, elevator business is not only a product, but also a kind of service. Secondly, for our partners, our aim is not only make you gain money, but also try our best to support and cultivate you to grow up with us. Thirdly, we believe in team work, the power of individual is limited, but the power of team is infinite.

It is always a pleasure to greet you to talk about cooperation plan with us. We work together, happy together!

我们是一群电梯行业的深度从业者，过去几十年经验告诉我们，仍然有很多行业痛点亟待解决，比如电梯的定制化设计，电梯专业工程师的短缺，电梯安装的质量把控，电梯售后的系统化，以及陈旧的电梯代理合作方式等等，所有这些大多数的电梯供应商都没有认真对待，他们仍然以大众化的产品，普通的服务，以及电梯一旦卖出就宣告生意结束的落后理念，越来越无法满足海外市场的本地化服务的要求。因此，我们建立了这家公司——苏州艾尔奇电梯有限公司，旨在提供优质产品的同时，聚焦本地化服务，培养本地的代理商和合作伙伴，将电梯合作上升到一个新高度。

我们虽然是一个年轻的公司，但是我们的员工都是电梯行业的资深从业者。如车间工人都是5-15年经验的熟练工，技术工程师都是这个行业长期工作拥有20-30年经验的身经百战的技术能手，我们的业务员都是经过严格的培训，筛选，考核，最终才能留下的。我们相信我们这样的团队必定能为您提供最用心服务的。

我们始终认为：第一，电梯不仅是一个产品，更是一种服务，持续10-20年的服务；第二，对于合作伙伴，我们不仅是要让你们赚到钱，更要想方设法去支持你们，培养你们从小做大，一同成长；第三，我们信奉团队合作，个人的力量是有限的，团队的力量是无穷的。

我们欢迎有志在电梯行业发展的朋友们，前来商谈合作。一同工作一同欢乐！



ENTERPRISE CERTIFICATE

企业证书

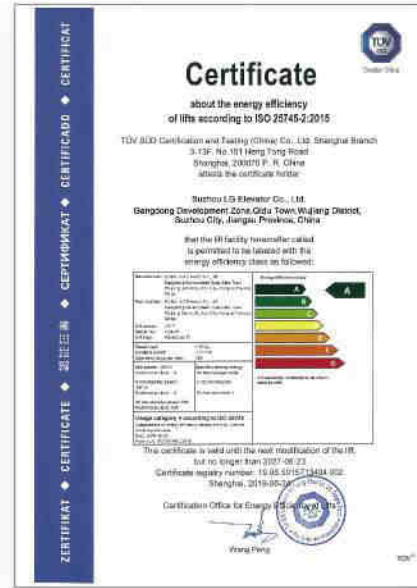
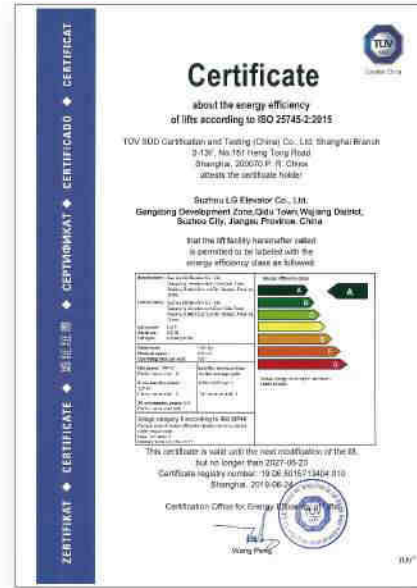
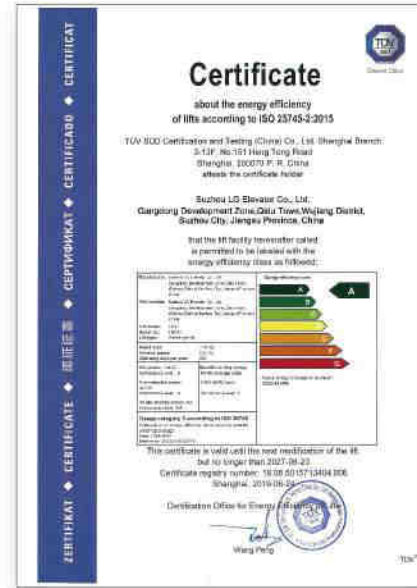
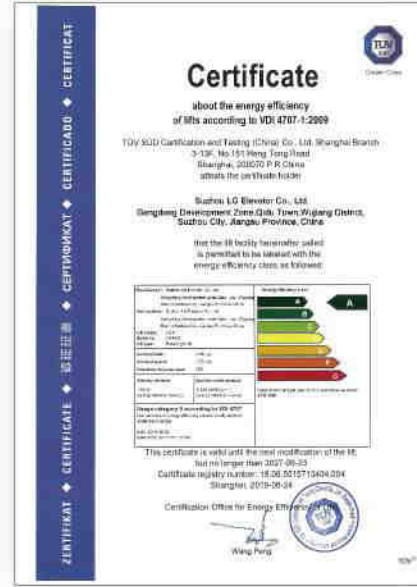
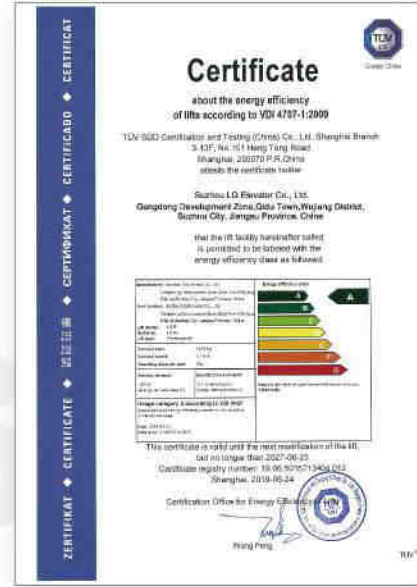
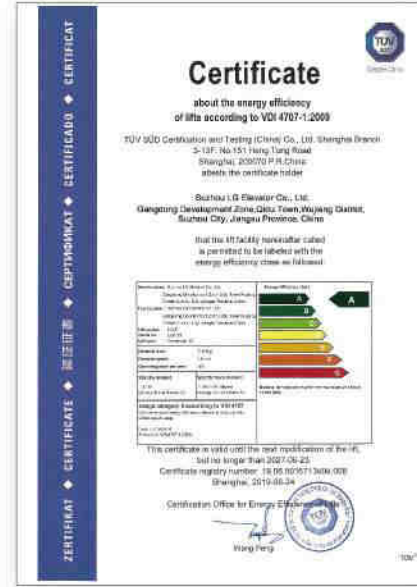
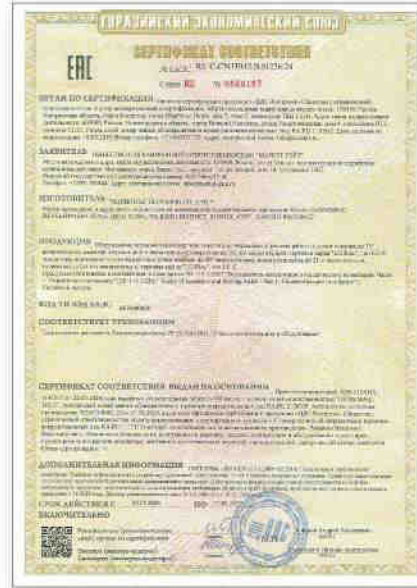
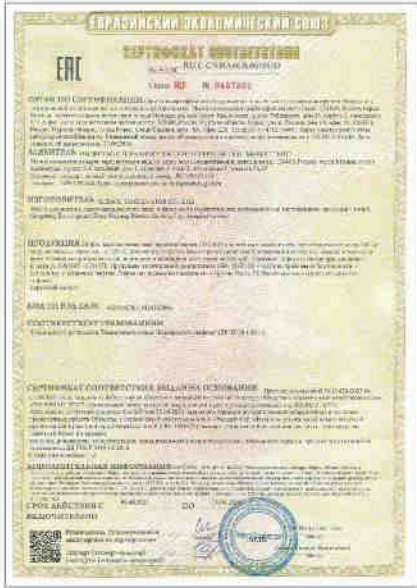

GEARLESS TRACTION MACHINE

无齿轮曳引机

Torin Motor 通润主机



GTW7A



GTW9S



ERSL



ER1L

MONA Drive Motor 蒙特纳利主机



MCK200



MCK300



MONA200



MONA320

Furder Motor 弗尔德主机



FRD21E(320-450kg)



FRD21E(630kg)



FRD32E



FRD40A

Belt Motor 钢带主机



FAXI65S/FAXI86S Series



FAXI100B Series



FAXI100E-FG Series



FAXI120C Series

DOOR OPERATOR SERIES

门机系列

Ouling door operator 欧菱门机



Shenling door operator 申菱门机



Wittur door operator 威特门机

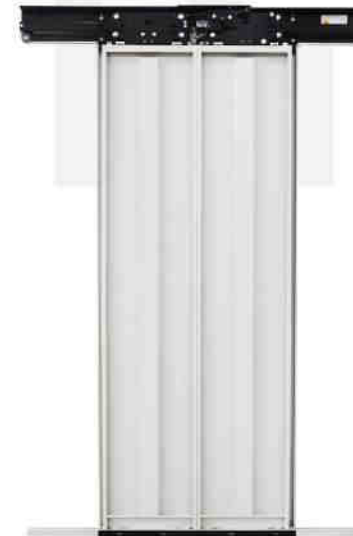

Fermator door operator 佛马特门机



3rd Generation Control Cabinet

第三代控制柜

Product Features 产品特点

1. More Cost-Effective

更具成本效益

The new solution features 30% less traveling cable cores than conventional products and requires only 10 cores for connection between the car top box and a car, significantly reducing the cost of electrical accessory components.

新的解决方案的特点是,与传统产品相比,随行电缆芯数减少了30%,并且只需要10芯用于连接轿顶检修箱和轿厢,大大降低了电气配件的成本。

2. Slimmer

更苗条

It is 20% smaller than a conventional control cabinets
它比传统控制柜小20%。

3. Safer

更安全

All power circuits are protected by RCDs (GB7588.1).
所有电源电路都受RCD保护(GB7588.1)

4. Compliant with New Standards

符合新标准

The standard configuration includes UCMP and the door lock short circuit detection and door bypass functions. The space for installing a filter board is provided to address the EMC requirements specified in GB7588.1.

标准配置包括UCMP和门锁短路检测和门旁路功能。提供了安装滤板的空间,以满足GB7588.1中规定的EMC要求。

Product Dimensions 产品尺寸

Dimensions of a control cabinet (Machine room)

控制柜(机房)的尺寸

Type 类型	Dimensions(mm) 尺寸(毫米)	Installation Mode 安装模式
5.5 - 15 kw	970 x 430 x 220	Wall-mounting/Floor 壁挂/地面
18.5 - 22 kw	1220 x 470 x 250	Floor standing 落地
30 - 37 kw	1320 x 510 x 275	Floor standing 落地

Dimensions of a control cabinet (Machine-room-less)

控制柜(无机房)的尺寸

Type 类型	Dimensions(mm)(Excluding Resistance Box) 尺寸(毫米)(不包括电阻箱)
5.5 - 22 kw	350x240x1350mm
30 - 37 kw	400x250x1500mm

Product Code 产品代码

Cabinet type Voltage level Power level
柜型 电压水平 功率级

NICE3000 - B - 40 15 - A

NICE3000 integrated controller
NICE3000 集成控制器

Model
型号



Machine room
机房



Machine-room-less
无机房

PRODUCT INTRODUCTION

产品介绍

Passenger Elevator 乘客电梯

Our passenger elevators help people reach the floors quickly, comfortably, safely, and run quietly which is especially important at night. We make elevators be integrated into the buildings, and try to help building owners to reduce cost for total elevator lifetime with excellent solutions.

我们的客梯可承载人们快速、舒适、安全地到达指定楼层,而且运行地很安静,这在晚上尤其重要。我们设计的电梯方案能让电梯与建筑物融为一体,帮助业主减少电梯整个生命周期的运行成本。



Panoramic Elevator 观光电梯

Our panoramic elevators are generally running in open environments like shopping malls, hotels, office buildings etc. We have various of designs for cabins which are elegant and beautiful, attract people's attention greatly. Your buildings must reach a higher level with our panoramic elevators.

我们的观光电梯通常在开放的环境下运行,如购物中心,酒店,写字楼等。我们有各种轿厢设计,美丽大方,极大地吸引人们的注意。您的建筑物必定会因为我们的观光电梯而展现出一个新的高度。



Home Elevator 家用电梯

With our home elevator solutions, you can bring your ideal vision to life. We have a variety of cabin designs, there is always one for you. Even no pit, or the space limited, we can design a matched home elevator for you.

我们的家用电梯解决方案,让您的理想照进现实。我们拥有各式各样的轿厢设计,总有一款适合您。甚至没有底坑或者空间很有限,我们也能为您设计最适合的家用电梯。



Hospital Bed Elevator 医用电梯

Our hospital bed elevators have large capacity and wide opening doors to accommodate stretchers, beds and other medical equipment, precise levelling to allow easy access for wheelchairs.

当电梯被冠以“医用”之名,则被赋予了神圣的使命。在设计时不仅要充分考虑到电梯本身的安全舒适的基本功能,还需根据医用的特定需求,提供更加宽敞和安静的乘坐空间,也需要更大的开门宽度以便担架病床等医疗设备的出入。



Escalator 自动扶梯

Our serial escalators use reliable materials and branded parts, with strong structure, to keep escalators smooth running for long time with lower noise and low-cost maintenance. They become indispensable part of shopping malls, multiplex cinema, museums, train and metro stations, airports etc.

我们的自动扶梯采用可靠的原材料和知名的部件,拥有非常坚固的结构,保证其长久稳固地运行,且噪音低,维保成本低。它们已经成为购物中心,电影院,博物馆,火车站,地铁站,机场等不可或缺的重要部分。

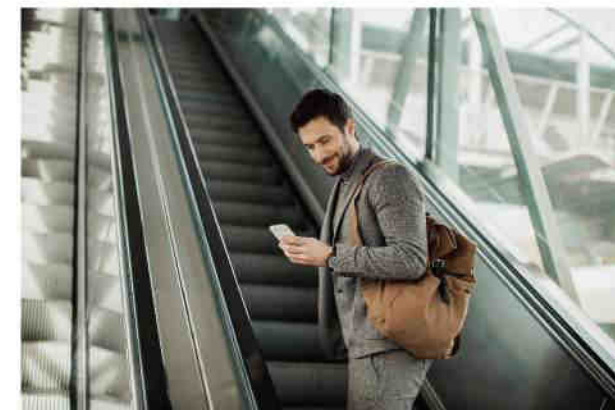

Freight Elevator 载货电梯

Our freight elevators are specially designed for the transportation of cargoes, big door opening, spacious cabin, strong structure, to ensure safe and steady running when loading large cargoes and people. They are the best transportation machines for factories, warehouses, and malls etc.

我们的载货电梯专为货物运输而设计,宽大的开门,宽敞的轿厢,坚固的结构,保证了在运输大量货物和人员的时候依然能保持安全稳定的运行。它们已经成为工厂、仓库和商场等场所的最佳货运工具。



Moving Sidewalk 自动人行道

Our moving sidewalks have strong structure and high performance as our escalators. When your site has small angle but long span, you can choose moving sidewalks. They are popular using in high-grade shopping center, airport, big indoor place etc.

我们的自动人行道跟自动扶梯一样,拥有非常坚固的结构和高效的性能。当您的现场满足倾斜角度小但跨度很大的时候,您就可以选择自动人行道。它们被用于高档购物中心,机场和其他大型的室内场所。

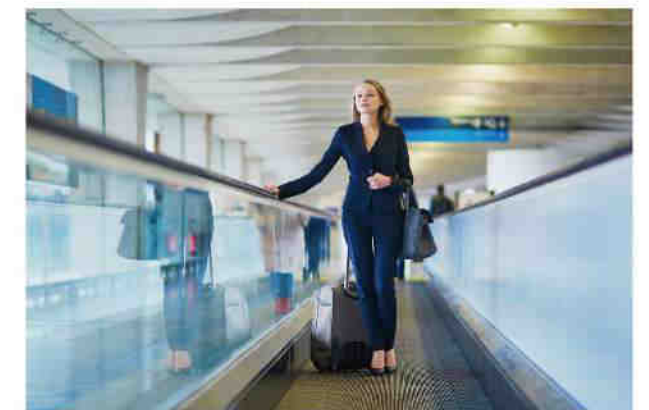

ELEVATOR PROFILE VIEWS

电梯剖面图



Efficient traction machine
高效曳引机

Control system
控制系统

Door operator
永磁同步门机

Car
轿厢

Door
门板

SAFETY PARTS

各安全部件

Main engine brake: Motor brake can precisely stop motor running to stop elevator runs in abnormal speed.

主机抱闸:当电梯运行速度出现异常,主机抱闸立刻工作,通过刹车来停止主机运行,从而停止电梯的运行。

Door lock: There is the cam body set in the switching range of the door of the elevator room in the lifting pathway. The cam body used to specify the opening and closing zone of the elevator door is arranged on the side wall of the elevator door, and is combined with the mobile selection component to restrict the opening of the door of the elevator room outside the opening and closing zone of the elevator door.

门锁:具有设置在升降通路中的电梯间门的开闭区间上,用来规定电梯间门的开闭区间的凸轮体;设置在电梯间的侧壁上,在电梯间门的开闭区间之外与上述移动选择构件配合起来限制住电梯间的门打开的限制构件。

Safety gear: Safety gear is suitable to be installed on the two sides or bottom of the lower beam. When the car descends at excessive speed, following the actuation of the speed governor, the speed governing wire rope will lift the rocker arm and enable the safety gear clamping the guide rails and stop the car to protect people inside.

安全钳:安全钳一般是安装在轿底下梁的两侧或者底部。当电梯轿厢超速下降从而引起限速器作用于钢丝绳,进而安全钳联动,从而能有效地停止电梯轿厢,保护乘客。

Buffer: Elevator buffers are designed to protect people and equipment from forces generated from an impact resulting from equipment failure or operator error. To minimize the damages of elevator accident.

缓冲器:电梯缓冲器设计,以保护人员和设备故障或操作失误造成的冲击产生的力。将电梯事故造成的损失最大限度地减少。

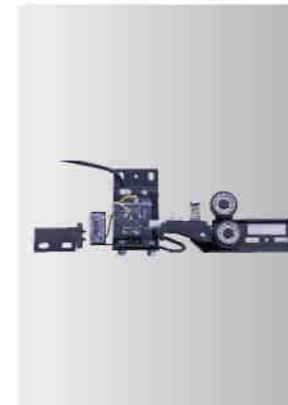

Overload device: The overload device can prevent the elevator door from closing, when the load of the elevator exceeds its rated load. In the meanwhile, buzzer or display warning.

超载装置:超载装置在检测到电梯实际载重超过其额定载重时,保护电梯门防止其关闭,从而阻止电梯运行,并同时蜂鸣器响起或者显示报警。

Overspeed governor: Overspeed governor is generally installed in machine room or on top of guide rails. If the elevator descends more than 115% of rated speed, the overspeed governor will find this emergency immediately and actuate safety gear action and stop the car, playing the role of over-speed protection.

限速器:限速器一般安装在机房或者导轨上。当电梯轿厢超过额定速度115%,限速器会立刻感应到这一突发情况,拉动安全钳夹住导轨,停止电梯轿厢。

Limit switch: Limit switch is also called travel switch, is a popular small current main electrical appliances. Use the collision of mechanical moving parts to connect or break the control circuit, to achieve a certain control purpose. It can protect elevator running in a safe distance.

限位开关:限位开关又被称为行程开关,是常用的小电流电气部件。利用生产机械运动部件的碰撞使其触头动作来实现接通或分断控制电路,达到一定的控制目的。它可以保护电梯行驶在安全距离内。

Light curtain protection: The infrared receiver with rays is applied to form an infrared protection network outside the elevator door, which enhances the reliability of the whole elevator system as well as provides passengers with maximum security assurance.

光幕保护:采用红外线发生接收器,在电梯门口形成一幅红外保护网。不仅为电梯乘客提供最大限度的安全保障,而且增强了整个电梯系统的可靠性。





PASSENGER ELEVATOR

乘客电梯

Small Machine Room Passenger Elevator

小机房乘客电梯

Small machine room passenger elevator applies the rational construction layout. Machine room is about the same as the well size. It effectively saves the occupation rate of machine room space. Small machine room design grants the elevator to more easily merge with the building. It greatly reduces the restrictions of the building outline design. It reduces the building space cost. What is more, it inspires infinite creativity of the building designers.

小机房乘客电梯采用合理的土建布局,实现了机房面积与井道的一致大小,有效节省了机房空间占有率。小机房的设计,使电梯更容易融入建筑,且大大降低了建筑外观设计的束缚,不仅降低了建筑的空间成本,更激发了建筑设计师的无限创造力。

Environment protection type traction system with fierce motives

动力强劲的环保型曳引系统

It applies small bulk, light weight, high drive efficiency permanent magnet synchronous and gearless traction machine. Its area is only half of the traditional traction machine. It thus greatly reduces the machine room area. It fulfills a key step of small machine room design.

采用体积小、重量轻、驱动效率高的永磁同步无齿轮曳引机,所需面积只要传统曳引机的一半,从而大大降低机房面积,实现了小机房设计的关键一步。

255mm

Reduce the height of the machine room 255mm
降低机房高度

40%

Small machine room elevator, save machine-room area
小机房电梯,节省机房面积

Passenger elevator, it's not just a loading machine, it become a part of people's life.

乘客电梯,它不只是一种提升设备,它已经成为人们生活的一部分。

Machine Roomless Passenger Elevator

无机房乘客电梯

Machine roomless passenger elevator, with an environment concern, saves energy and reduces the consumption, saves the construction area and increases the freeness of designers, thereby fully reflect the idea of environment friendly culture. Compared with the gearwheel elevators with the same load capacity, machine roomless elevators save 25% electricity and 10% of construction area. Machine roomless passenger elevator has broken through the prerequisite that machine rooms must be available for elevators, providing limitless possibilities of creation for the limited space of modern construction.

无机房乘客电梯,深谙环保理念,节能降耗,节约建筑面积,提高设计自由度,充分体现绿色人文。与同等载重量级别的有齿轮电梯相比,节约电能25%,节约建筑面积10%。无机房乘客电梯突破了电梯必须设置机房的前提,为现代建筑有限空间提供了无限创造的可能。

Blended into the construction, easily and leisurely

融入建筑 轻松自如

Machine roomless passenger elevator need only one independent hoist-way and do not need the presence of machine rooms. The architects and developers are allowed to conduct designing in a freer way.

无机房乘客电梯只需要一个自己独立的井道空间,无需机房。建筑师和开发商可以更为自由的进行设计。

Saving the costs for construction

节约建筑成本

Machine roomless passenger elevator take less space, which enables you to effectively utilize the construction space. installation ensures affect freeness to the engineering caused by the installation of elevators.

无机房乘客电梯它能节约建筑时间、材料和成本。将机房与井道融为一体的设计,保证不会因为电梯安装而给工程带来任何影响。

100%

Machine roomless elevator, pure utility of construction area
无机房电梯,建筑空间纯利用率

25%

It saves 25% of electric energy
节约电能



PASSENGER ELEVATOR

乘客电梯



3D display



LG-K01 (Standard 标配)

Side wall: Hairline stainless steel
Rear wall: Hairline stainless steel
Ceiling: Hairline stainless steel + LED lights
Floor: PVC/Marble
Handrail: LG-H01 Single tube mirror
COP: LG-CZ002
HOP: LG-WH001

侧壁:发纹不锈钢
后壁:发纹不锈钢
吊顶:发纹不锈钢+LED灯
地板:PVC/大理石
扶手:LG-H01 单管镜面
操纵箱:LG-CZ002
外呼:LG-WH001

LG-H01



PASSENGER ELEVATOR

乘客电梯



3D display



LG-K02

Side wall: Hairline stainless steel + Mirror etched stainless steel
Rear wall: Hairline stainless steel + Mirror stainless steel
Ceiling: Hairline stainless steel + LED lights
Floor: PVC/Marble
Handrail: LG-H01 Single tube mirror
COP: LG-CZ002
HOP: LG-WH001

侧壁:发纹不锈钢+镜面蚀刻不锈钢
后壁:发纹不锈钢+镜面不锈钢
吊顶:发纹不锈钢+LED灯
地板:PVC/大理石
扶手:LG-H01 单管镜面
操纵箱:LG-CZ002
外呼:LG-WH001

LG-H01



Passenger Elevator Cabins
乘客电梯轿厢

PASSENGER ELEVATOR

乘客电梯



LG-K03

Side wall: Hairline stainless steel
 Rear wall: Hairline stainless steel + Mirror etched stainless steel
 Ceiling: Hairline stainless steel + LED lights
 Floor: PVC/Marble
 Handrail: LG-H09 Hairline stainless steel
 COP: LG-CZ002
 HOP: LG-WH001

侧壁:发纹不锈钢
 后壁:发纹不锈钢+镜面蚀刻不锈钢
 吊顶:发纹不锈钢+LED灯
 地板:PVC/大理石
 扶手:LG-H09 发纹不锈钢
 操纵箱:LG-CZ002
 外呼:LG-WH001



LG-CZ002



3D display



LG-WH001



LG-H09

PASSENGER ELEVATOR

乘客电梯



LG-K04

Side wall: Hairline stainless steel
 Rear wall: Hairline stainless steel + Mirror etched stainless steel
 Ceiling: Mirror stainless steel + LED lights
 Floor: PVC/Marble
 Handrail: LG-H01 Single tube mirror
 COP: LG-CZ002
 HOP: LG-WH001

侧壁:发纹不锈钢
 后壁:发纹不锈钢+镜面蚀刻不锈钢
 吊顶:镜面不锈钢+LED灯
 地板:PVC/大理石
 扶手:LG-H01 单管镜面
 操纵箱:LG-CZ002
 外呼:LG-WH001



LG-CZ002



3D display



LG-WH001



LG-H01

PASSENGER ELEVATOR

乘客电梯



LG-K05 (Standard 标配)

Side wall: Hairline stainless steel + Mirror etched stainless steel
 Rear wall: Hairline stainless steel + Mirror etched stainless steel
 Ceiling: Hairline stainless steel + LED lights
 Floor: PVC/Marble
 Handrail: LG-H01 Single tube mirror
 COP: LG-CZ002
 HOP: LG-WH001

侧壁:发纹不锈钢+镜面蚀刻不锈钢
 后壁:发纹不锈钢+镜面蚀刻不锈钢
 吊顶:发纹不锈钢+LED灯
 地板:PVC/大理石
 扶手:LG-H01 单管镜面
 操纵箱:LG-CZ002
 外呼:LG-WH001



LG-CZ002



3D display



LG-WH001



LG-H01

PASSENGER ELEVATOR

乘客电梯



LG-K06

Side wall: Mirror etched stainless steel + Hairline stainless steel
 Rear wall: Mirror etched stainless steel + Hairline stainless steel
 Ceiling: Hairline stainless steel+LED lights
 Floor: PVC/Marble
 Handrail: LG-H01 Single tube mirror
 COP: LG-CZ002
 HOP: LG-WH001

侧壁:镜面蚀刻不锈钢+发纹不锈钢
 后壁:镜面蚀刻不锈钢+发纹不锈钢
 吊顶:发纹不锈钢+LED灯
 地板:PVC/大理石
 扶手:LG-H01 单管镜面
 操纵箱:LG-CZ002
 外呼:LG-WH001



LG-CZ002



3D display



LG-WH001



LG-H01

PASSENGER ELEVATOR

乘客电梯



LG-K07

Side wall: Mirror stainless steel + Hairline stainless steel
 Rear wall: Hairline stainless steel + Mirror etched stainless steel
 Ceiling: Mirror stainless steel + LED lights
 Floor: PVC/Marble
 Handrail: LG-H01 Single tube mirror
 COP: LG-CZ002
 HOP: LG-WH001

侧壁: 镜面不锈钢+发纹不锈钢
 后壁: 发纹不锈钢+镜面蚀刻不锈钢
 吊顶: 镜面不锈钢+LED灯
 地板: PVC/大理石
 扶手: LG-H01 单管镜面
 操纵箱: LG-CZ002
 外呼: LG-WH001



LG-CZ002



3D display



LG-WH001



LG-H01

PASSENGER ELEVATOR

乘客电梯



LG-K08

Side wall: Hairline stainless steel
 Rear wall: Titanium etched stainless steel + Mirror stainless steel
 Ceiling: Mirror stainless steel + LED lights
 Floor: PVC/Marble
 Handrail: LG-H01 Single tube mirror
 COP: LG-CZ002
 HOP: LG-WH001

侧壁: 发纹不锈钢
 后壁: 钛金蚀刻不锈钢+镜面不锈钢
 吊顶: 镜面不锈钢+LED灯
 地板: PVC/大理石
 扶手: LG-H01 单管镜面
 操纵箱: LG-CZ002
 外呼: LG-WH001



LG-CZ002



3D display



LG-WH001



LG-H01

PASSENGER ELEVATOR

乘客电梯

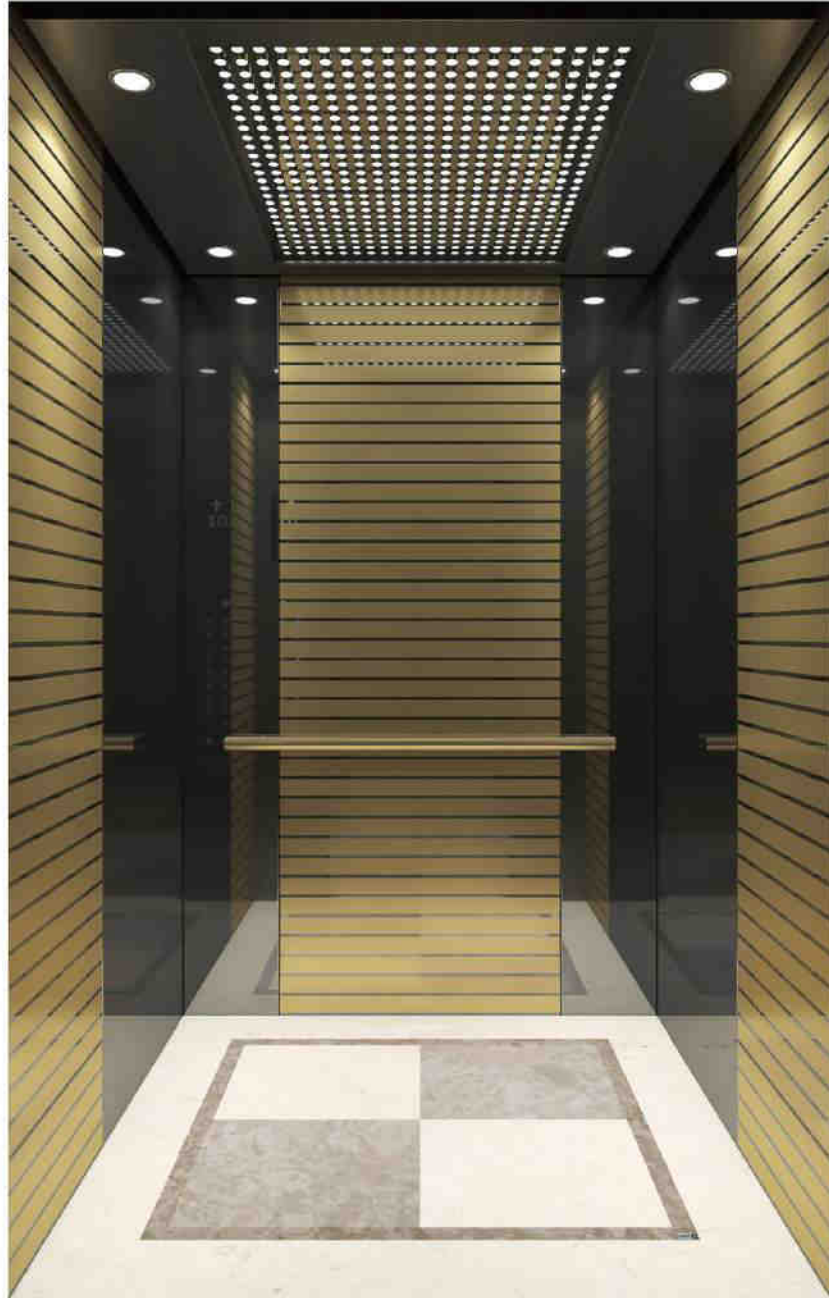

LG-K09

Side wall: Titanium etched stainless steel + Titanium black mirror stainless steel
 Rear wall: Titanium etched stainless steel + Titanium black mirror stainless steel
 Ceiling: Titanium black hairline stainless steel + LED lights
 Floor: PVC/Marble
 Handrail: LG-H02 Titanium mirror stainless steel
 COP: LG-CZ002
 HOP: LG-WH001

侧壁: 钛金蚀刻不锈钢+钛黑镜面不锈钢
 后壁: 钛金蚀刻不锈钢+钛黑镜面不锈钢
 吊顶: 钛黑发纹不锈钢+LED灯
 地板: PVC/大理石
 扶手: LG-H02 钛金镜面不锈钢
 操纵箱: LG-CZ002
 外呼: LG-WH001



LG-CZ002



3D display



LG-WH001



LG-H02

PASSENGER ELEVATOR

乘客电梯



LG-K10

Side wall: Laminated steel + mirror stainless steel
 Rear wall: Laminated steel + mirror stainless steel
 Ceiling: Hairline stainless steel + LED lights
 Floor: PVC/Marble
 Handrail: LG-H11 Solid wood, stainless steel on both side
 COP: LG-CZ002
 HOP: LG-WH001

侧壁: 彩纹钢板+镜面不锈钢
 后壁: 彩纹钢板+镜面不锈钢
 吊顶: 发纹不锈钢+LED灯
 地板: PVC/大理石
 扶手: LG-H11 实木, 两边不锈钢
 操纵箱: LG-CZ002
 外呼: LG-WH001



LG-CZ002



3D display



LG-WH001



LG-H11

PASSENGER ELEVATOR

乘客电梯

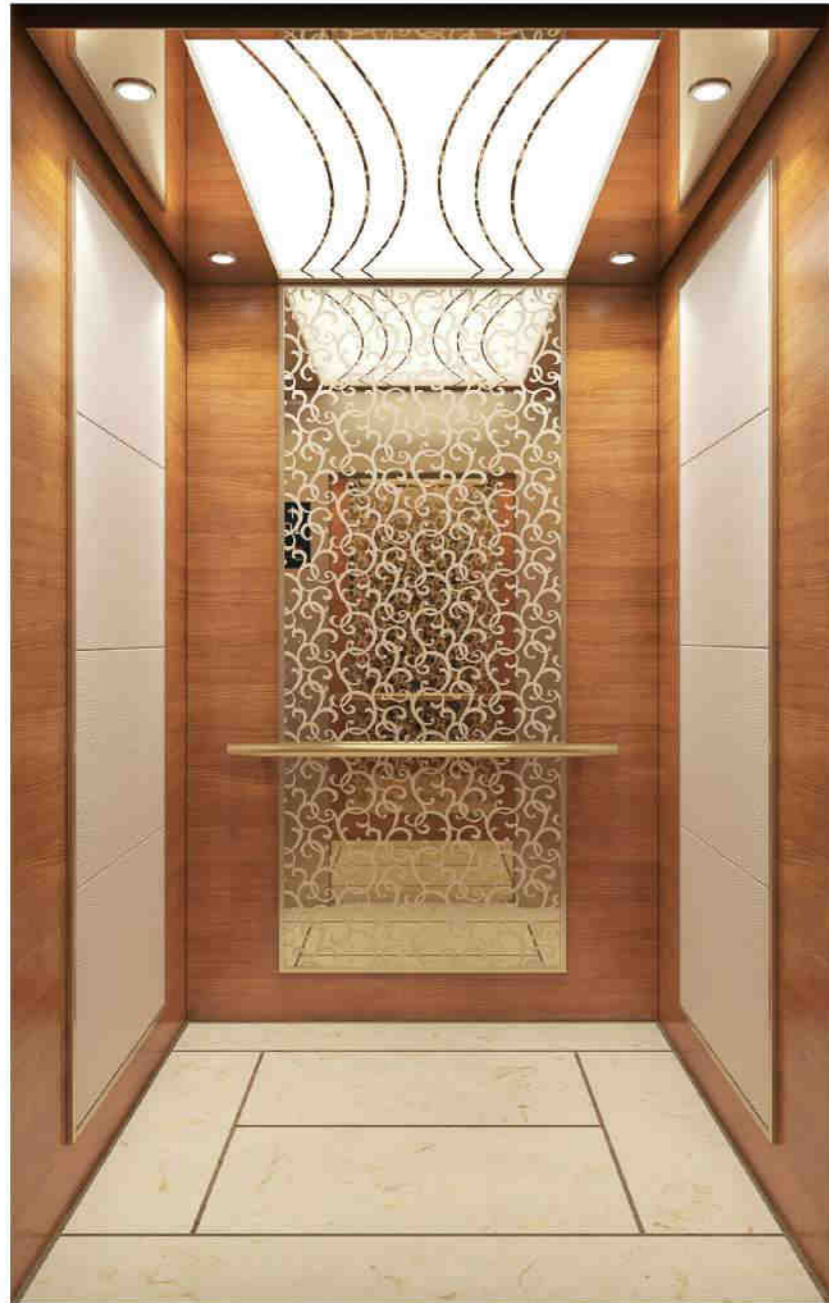

LG-K11

Side wall: Wood + Leather
 Rear wall: Wood + Titanium mirror etching stainless steel
 Ceiling: Titanium mirror stainless steel + LED lights
 Floor: PVC/Marble
 Handrail: LG-H02 Titanium mirror stainless steel
 COP: LG-CZ002
 HOP: LG-WH001

侧壁:木板+真皮贴面
 后壁:木板+钛金镜面蚀刻不锈钢
 吊顶:钛金镜面不锈钢+LED灯
 地板:PVC/大理石
 扶手:LG-H02 钛金镜面不锈钢
 操纵箱:LG-CZ002
 外呼:LG-WH001



LG-CZ002



3D display



LG-WH001



LG-H02

PASSENGER ELEVATOR

乘客电梯

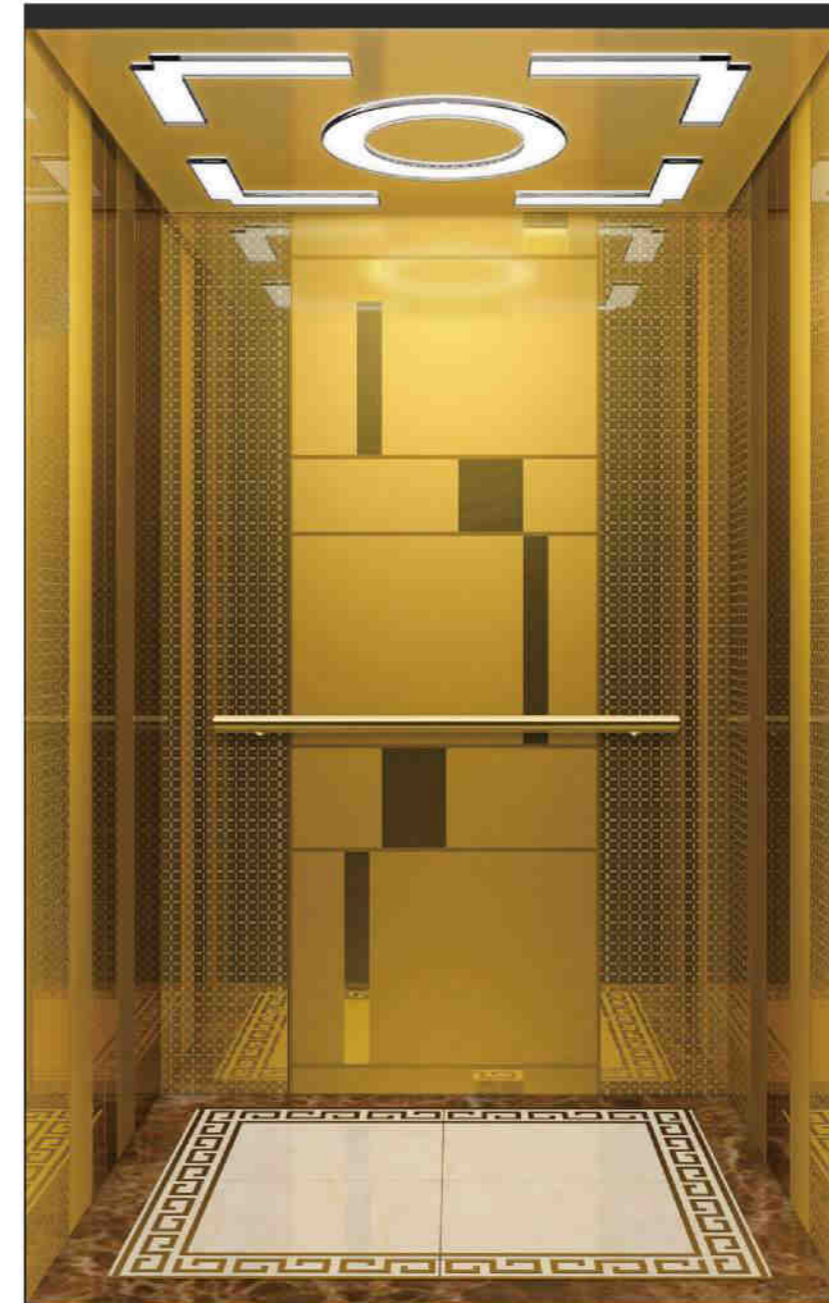

LG-K12

Side wall: Titanium mirror etched stainless steel + Titanium stainless steel
 Rear wall: Titanium mirror etched stainless steel + Titanium stainless steel
 Ceiling: Titanium mirror stainless steel + LED lights
 Floor: PVC/Marble
 Handrail: LG-H02 Titanium mirror stainless steel
 COP: LG-CZ002
 HOP: LG-WH001

侧壁:钛金镜面蚀刻不锈钢+钛金不锈钢
 后壁:钛金镜面蚀刻不锈钢+钛金不锈钢
 吊顶:钛金镜面不锈钢+LED灯
 地板:PVC/大理石
 扶手:LG-H02 钛金镜面不锈钢
 操纵箱:LG-CZ002
 外呼:LG-WH001



LG-CZ002



3D display



LG-WH001



LG-H02

PASSENGER ELEVATOR

乘客电梯



LG-K13

Side wall: Titanium mirror etched stainless steel + Titanium stainless steel
 Rear wall: Titanium mirror etched stainless steel + Titanium stainless steel
 Ceiling: Titanium mirror stainless steel
 Floor: PVC/Marble
 Handrail: LG-H10B Titanium mirror stainless steel
 COP: LG-CZ002
 HOP: LG-WH001

侧壁: 钛金镜面蚀刻不锈钢+钛金不锈钢
 后壁: 钛金镜面蚀刻不锈钢+钛金不锈钢
 吊顶: 钛金镜面不锈钢
 地板: PVC/大理石
 扶手: LG-H10B 钛金镜面不锈钢
 操纵箱: LG-CZ002
 外呼: LG-WH001



LG-CZ002



3D display



LG-WH001



LG-H10B

PASSENGER ELEVATOR

乘客电梯



LG-K14

Side wall: Titanium mirror stainless steel + Titanium stainless steel
 Rear wall: Titanium mirror etched stainless steel + Titanium stainless steel
 Ceiling: Titanium mirror stainless steel + LED lights
 Floor: PVC/Marble
 Handrail: LG-H02 Titanium stainless steel
 COP: LG-CZ002
 HOP: LG-WH001

侧壁: 钛金镜面不锈钢+钛金不锈钢
 后壁: 钛金镜面蚀刻不锈钢+钛金不锈钢
 吊顶: 钛金镜面不锈钢+LED灯
 地板: PVC/大理石
 扶手: LG-H02 钛金不锈钢
 操纵箱: LG-CZ002
 外呼: LG-WH001



LG-CZ002



3D display



LG-WH001



LG-H02

PASSENGER ELEVATOR

乘客电梯



LG-K15

Side wall: Hairline stainless steel + Rose gold etched stainless steel
 Rear wall: Hairline stainless steel + Rose gold stainless steel
 Ceiling: Mirror stainless steel + LED lights
 Floor: PVC/Marble
 Handrail: LG-H10 Rose gold mirror stainless steel
 COP: LG-CZ002
 HOP: LG-WH001

侧壁:发纹不锈钢+玫瑰金蚀刻不锈钢
 后壁:发纹不锈钢+玫瑰金不锈钢
 吊顶:镜面不锈钢+LED灯
 地板:PVC/大理石
 扶手:LG-H10 玫瑰金镜面不锈钢
 操纵箱:LG-CZ002
 外呼:LG-WH001



LG-CZ002



3D display



LG-WH001



LG-H10

PASSENGER ELEVATOR

乘客电梯



LG-K16

Side wall: Coffee color mirror stainless steel + Coffee color hairline stainless steel
 Rear wall: Coffee color mirror etched stainless steel + Coffee color hairline stainless steel
 Ceiling: Coffee color hairline stainless steel + LED lights
 Floor: PVC/Marble
 Handrail: LG-H10C Coffee color stainless steel
 COP: LG-CZ002
 HOP: LG-WH001

侧壁:咖啡色镜面不锈钢+咖啡色发纹不锈钢
 后壁:咖啡色镜面蚀刻不锈钢+咖啡色发纹不锈钢
 吊顶:咖啡色发纹不锈钢+LED灯
 地板:PVC/大理石
 扶手:LG-H10C 咖啡色不锈钢
 操纵箱:LG-CZ002
 外呼:LG-WH001



LG-CZ002



3D display



LG-WH001



LG-H10C

PASSENGER ELEVATOR

乘客电梯



LG-K17

Side wall: Rose gold mirror etched stainless steel+
Rose gold stainless steel
Rear wall: Rose gold mirror etched stainless steel
+ Rose gold stainless steel
Ceiling: Rose gold hairline stainless steel
Floor: PVC/Marble
Handrail: LG-H10 Rose gold mirror stainless steel
COP: LG-CZ002
HOP: LG-WH001

侧壁:玫瑰金镜面蚀刻不锈钢+玫瑰金不锈钢
后壁:玫瑰金镜面蚀刻不锈钢+玫瑰金不锈钢
吊顶:玫瑰金发纹不锈钢
地板:PVC/大理石
扶手:LG-H10 玫瑰金镜面不锈钢
操纵箱:LG-CZ002
外呼:LG-WH001



LG-CZ002



3D display



LG-WH001



LG-H10

PASSENGER ELEVATOR

乘客电梯

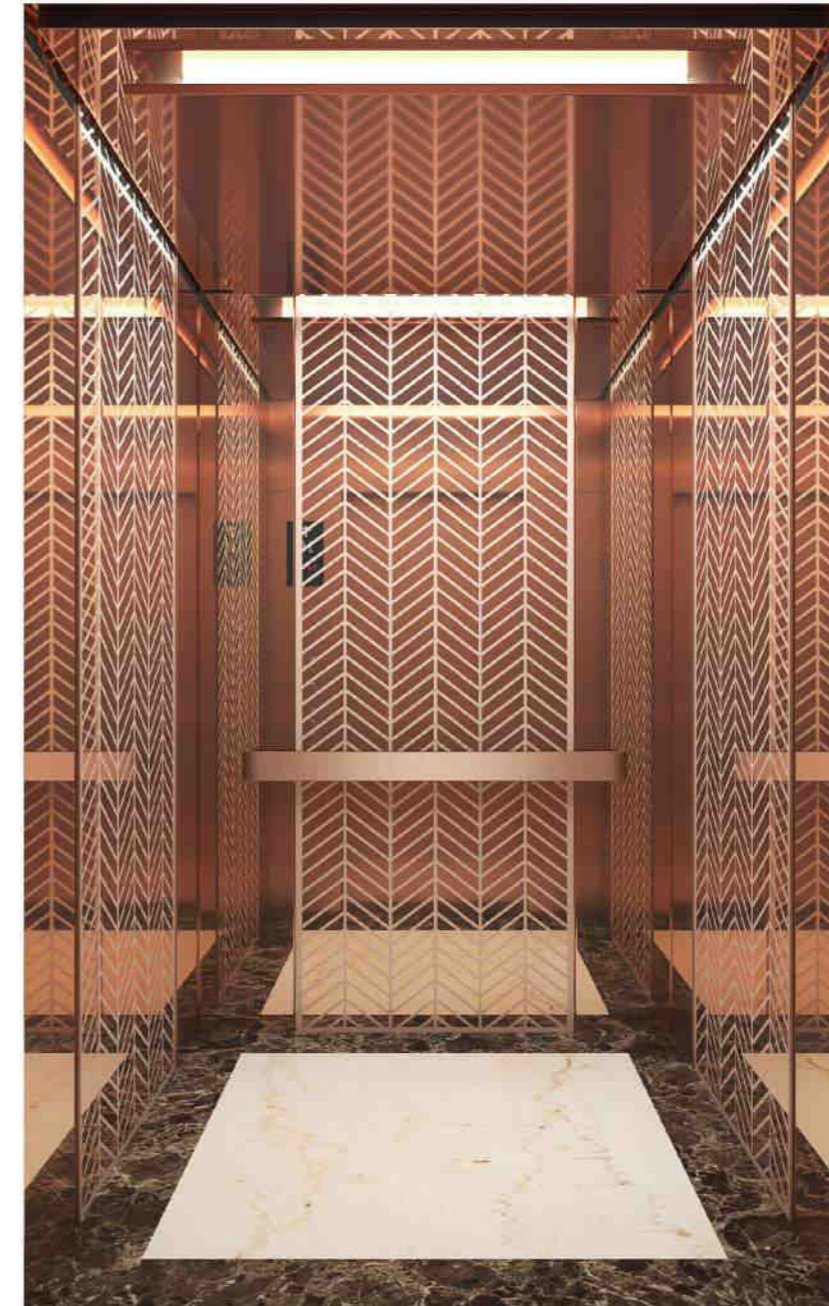

LG-K18

Side wall: Rose gold mirror etched stainless steel
+ Rose gold stainless steel
Rear wall: Rose gold mirror etched stainless steel
+ Rose gold stainless steel
Ceiling: Rose gold mirror stainless steel
Floor: PVC/Marble
Handrail: LG-H10 Rose gold mirror stainless steel
COP: LG-CZ002
HOP: LG-WH001

侧壁:玫瑰金镜面蚀刻不锈钢+玫瑰金不锈钢
后壁:玫瑰金镜面蚀刻不锈钢+玫瑰金不锈钢
吊顶:玫瑰金镜面不锈钢
地板:PVC/大理石
扶手:LG-H10玫瑰金镜面不锈钢
操纵箱:LG-CZ002
外呼:LG-WH001



LG-CZ002



3D display



LG-WH001



LG-H10

PASSENGER ELEVATOR

乘客电梯

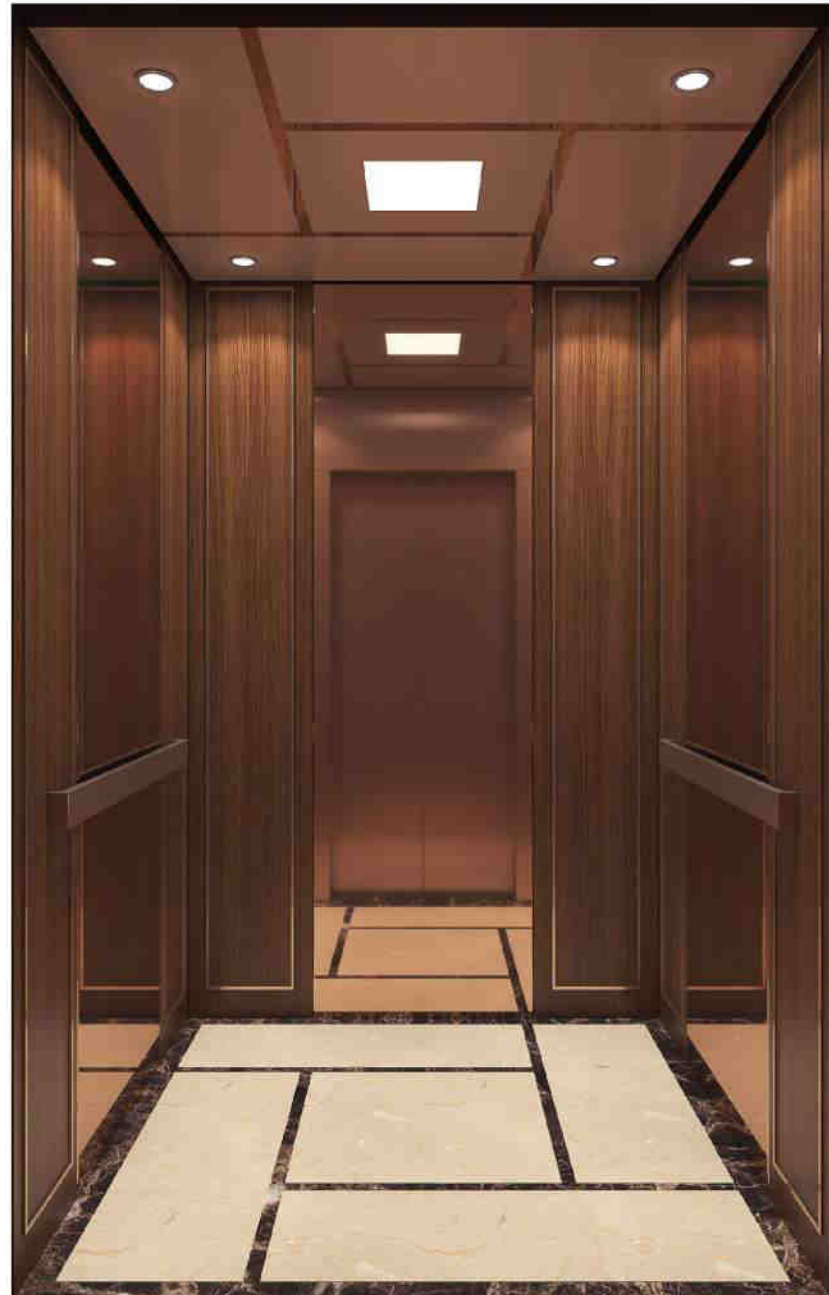

LG-K19

Side wall: Wood + rose gold mirror stainless steel
 Rear wall: Wood + rose gold mirror stainless steel
 Ceiling: Mirror stainless steel
 Floor: PVC/Marble
 Handrail: LG-H10 Rose gold mirror stainless steel
 COP: LG-CZ002
 HOP: LG-WH001

侧壁: 实木+玫瑰金镜面不锈钢
 后壁: 实木+玫瑰金镜面不锈钢
 吊顶: 镜面不锈钢
 地板: PVC/大理石
 扶手: LG-H10 玫瑰金镜面不锈钢
 操纵箱: LG-CZ002
 外呼: LG-WH001



LG-CZ002



3D display



LG-WH001



LG-H10

PASSENGER ELEVATOR

乘客电梯

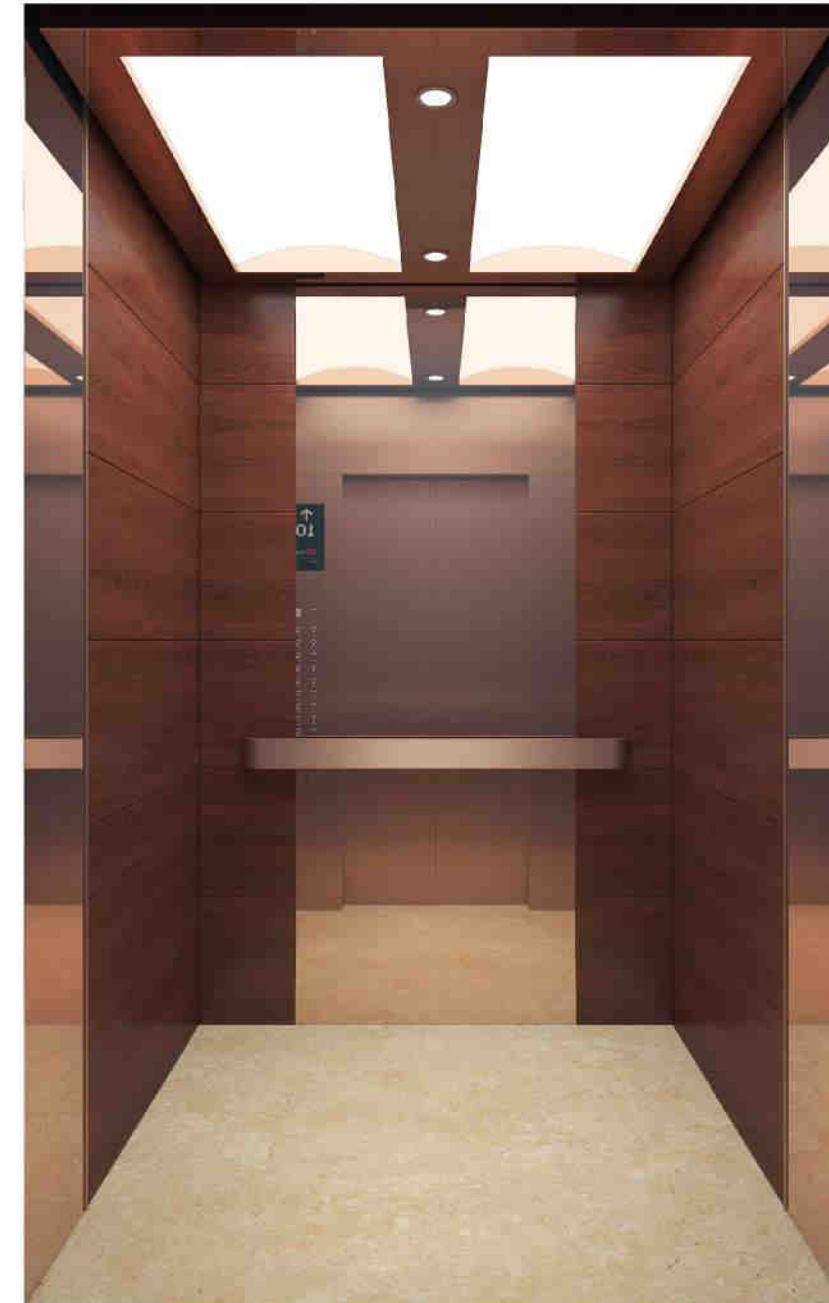

LG-K20

Side wall: Wooden grain + rose gold mirror stainless steel
 Rear wall: Wooden grain + rose gold mirror stainless steel
 Ceiling: Rose gold mirror stainless steel + LED light
 Floor: PVC/Marble
 Handrail: LG-H10 Rose gold mirror stainless steel
 COP: LG-CZ002
 HOP: LG-WH001

侧壁: 木纹钢板+玫瑰金镜面不锈钢
 后壁: 木纹钢板+玫瑰金镜面不锈钢
 吊顶: 玫瑰金镜面不锈钢+LED灯
 地板: PVC/大理石
 扶手: LG-H10 玫瑰金镜面不锈钢
 操纵箱: LG-CZ002
 外呼: LG-WH001



LG-CZ002



3D display



LG-WH001



LG-H10

MORE CAR STYLE

更多轿厢款式



LG-K21

Side wall: Mirror stainless steel + Hairline stainless steel
Rear wall: Mirror etched stainless steel + Hairline stainless steel
Ceiling: Hairline stainless steel+LED lights
Floor: PVC/Marble
Handrail: Single tube mirror
COP: LG-CZ002
HOP: LG-WH001
侧壁: 镜面不锈钢+发纹不锈钢
后壁: 镜面蚀刻不锈钢+发纹不锈钢
吊顶: 发纹不锈钢+LED灯
地板: PVC/大理石
扶手: 单管镜面
操纵箱: LG-CZ002
外呼: LG-WH001

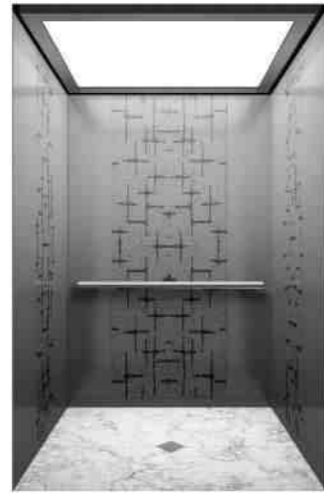

LG-K22

Side wall: Etched stainless steel + Hairline stainless steel
Rear Wall: Etched stainless steel + Hairline stainless steel
Ceiling: Mirror stainless steel + LED lights
Floor: PVC/Marble
Handrail: Single tube mirror
COP: LG-CZ002
HOP: LG-WH001
侧壁: 蚀刻不锈钢+发纹不锈钢
后壁: 蚀刻不锈钢+发纹不锈钢
吊顶: 镜面不锈钢+LED灯
地板: PVC/大理石
扶手: 单管镜面
操纵箱: LG-CZ002
外呼: LG-WH001



LG-K27

Side wall: Mirror etched stainless steel + Hairline stainless steel
Rear wall: Mirror etched stainless steel + Hairline stainless steel
Ceiling: Mirror stainless steel+LED lights
Floor: PVC/Marble
Handrail: Hairline stainless steel
COP: LG-CZ002
HOP: LG-WH001
侧壁: 镜面蚀刻不锈钢+发纹不锈钢
后壁: 镜面蚀刻不锈钢+发纹不锈钢
吊顶: 镜面不锈钢+LED灯
地板: PVC/大理石
扶手: 发纹不锈钢
操纵箱: LG-CZ002
外呼: LG-WH001



LG-K28

Side wall: Mirror stainless steel + Hairline stainless steel
Rear wall: Mirror stainless steel + Hairline stainless steel
Ceiling: Hairline stainless steel+LED lights
Floor: PVC/Marble
Handrail: Hairline stainless steel
COP: LG-CZ002
HOP: LG-WH001
侧壁: 镜面不锈钢+发纹不锈钢
后壁: 镜面不锈钢+发纹不锈钢
吊顶: 发纹不锈钢+LED灯
地板: PVC/大理石
扶手: 发纹不锈钢
操纵箱: LG-CZ002
外呼: LG-WH001



LG-K23

Side wall: Etched stainless steel + Mirror stainless steel
Rear wall: Etched stainless steel + Mirror stainless steel
Ceiling: Mirror stainless steel+LED lights
Floor: PVC/Marble
Handrail: Single tube mirror
COP: LG-CZ002
HOP: LG-WH001
侧壁: 蚀刻不锈钢+镜面不锈钢
后壁: 蚀刻不锈钢+镜面不锈钢
吊顶: 镜面不锈钢+LED灯
地板: PVC/大理石
扶手: 单管镜面
操纵箱: LG-CZ002
外呼: LG-WH001



LG-K24

Side wall: Etched stainless steel + Mirror etched stainless steel
Rear Wall: Etched stainless steel + Mirror etched stainless steel
Ceiling: Hairline stainless steel + LED lights
Floor: PVC/Marble
Handrail: Single tube mirror
COP: LG-CZ002
HOP: LG-WH001
侧壁: 蚀刻不锈钢+镜面蚀刻不锈钢
后壁: 蚀刻不锈钢+镜面蚀刻不锈钢
吊顶: 发纹不锈钢+LED灯
地板: PVC/大理石
扶手: 单管镜面
操纵箱: LG-CZ002
外呼: LG-WH001



LG-K29

Side wall: Mirror stainless steel + Hairline stainless steel
Rear wall: Mirror etched stainless steel + Hairline stainless steel
Ceiling: Mirror stainless steel+LED lights
Floor: PVC/Marble
Handrail: Single tube mirror
COP: LG-CZ002
HOP: LG-WH001
侧壁: 镜面不锈钢+发纹不锈钢
后壁: 镜面蚀刻不锈钢+发纹不锈钢
吊顶: 镜面不锈钢+LED灯
地板: PVC/大理石
扶手: 单管镜面
操纵箱: LG-CZ002
外呼: LG-WH001



LG-K30

Side wall: Mirror etched stainless steel + Hairline stainless steel
Rear wall: Mirror etched stainless steel + Hairline stainless steel
Ceiling: Mirror stainless steel+LED lights
Floor: PVC/Marble
Handrail: Single tube mirror
COP: LG-CZ002
HOP: LG-WH001
侧壁: 镜面蚀刻不锈钢+发纹不锈钢
后壁: 镜面蚀刻不锈钢+发纹不锈钢
吊顶: 镜面不锈钢+LED灯
地板: PVC/大理石
扶手: 单管镜面
操纵箱: LG-CZ002
外呼: LG-WH001



LG-K25

Side wall: Mirror etched stainless steel + Hairline stainless steel
Rear wall: Mirror etched stainless steel + Hairline stainless steel
Ceiling: Mirror stainless steel+LED lights
Floor: PVC/Marble
Handrail: Single tube mirror
COP: LG-CZ002
HOP: LG-WH001
侧壁: 镜面蚀刻不锈钢+发纹不锈钢
后壁: 镜面蚀刻不锈钢+发纹不锈钢
吊顶: 镜面不锈钢+LED灯
地板: PVC/大理石
扶手: 单管镜面
操纵箱: LG-CZ002
外呼: LG-WH001



LG-K26

Side wall: Mirror etched stainless steel + Hairline stainless steel
Rear wall: Mirror etched stainless steel + Hairline stainless steel
Ceiling: Mirror stainless steel+LED lights
Floor: PVC/Marble
Handrail: Acrylic flat
COP: LG-CZ002
HOP: LG-WH001
侧壁: 镜面蚀刻不锈钢+发纹不锈钢
后壁: 镜面蚀刻不锈钢+发纹不锈钢
吊顶: 镜面不锈钢+LED灯
地板: PVC/大理石
扶手: 亚克力扁
操纵箱: LG-CZ002
外呼: LG-WH001



LG-K31

Side wall: Mirror stainless steel + Hairline stainless steel
Rear wall: Mirror stainless steel + Hairline stainless steel
Ceiling: Hairline stainless steel + LED lights
Floor: PVC/Marble
Handrail: Single tube mirror
COP: LG-CZ002
HOP: LG-WH001
侧壁: 镜面不锈钢+发纹不锈钢
后壁: 镜面不锈钢+发纹不锈钢
吊顶: 发纹不锈钢+LED灯
地板: PVC/大理石
扶手: 单管镜面
操纵箱: LG-CZ002
外呼: LG-WH001



LG-K32

Side wall: Wooden grain + Hairline stainless steel
Rear wall: Wooden grain + Hairline stainless steel
Ceiling: Mirror stainless steel + LED lights
Floor: PVC/Marble
Handrail: Single tube mirror
COP: LG-CZ002
HOP: LG-WH001
侧壁: 木纹钢板+发纹不锈钢
后壁: 木纹钢板+发纹不锈钢
吊顶: 镜面不锈钢+LED灯
地板: PVC/大理石
扶手: 单管镜面
操纵箱: LG-CZ002
外呼: LG-WH001

MORE CAR STYLE

更多轿厢款式

MORE CAR STYLE

更多轿厢款式

MORE CAR STYLE

更多轿厢款式



LG-K33

Side wall: Titanium hairline stainless steel + Titanium mirror stainless steel
Rear wall: Titanium hairline stainless steel + Titanium mirror stainless steel
Ceiling: Titanium mirror stainless steel + LED lights
Floor: PVC/Marble
Handrail: Titanium stainless steel
COP: LG-CZ002
HOP: LG-WH001

侧壁: 钛金发纹不锈钢+钛金镜面不锈钢
后壁: 钛金发纹不锈钢+钛金镜面不锈钢
吊顶: 钛金镜面不锈钢+LED灯
地板: PVC/大理石
扶手: 钛金不锈钢
操纵箱: LG-CZ002
外呼: LG-WH001



LG-K34

Side wall: Titanium mirror etched stainless steel + Titanium stainless steel
Rear wall: Titanium mirror etched stainless steel + Titanium stainless steel
Ceiling: Titanium mirror stainless steel + LED lights
Floor: PVC/Marble
Handrail: Wooden grain + Titanium stainless steel
COP: LG-CZ002
HOP: LG-WH001

侧壁: 钛金镜面蚀刻不锈钢+钛金不锈钢
后壁: 钛金镜面蚀刻不锈钢+钛金不锈钢
吊顶: 钛金镜面不锈钢+LED灯
地板: PVC/大理石
扶手: 木纹+钛金不锈钢
操纵箱: LG-CZ002
外呼: LG-WH001



LG-K39

Side wall: Titanium mirror etched stainless steel + Rose gold stainless steel
Rear wall: Titanium mirror etched stainless steel + Rose gold stainless steel
Ceiling: Rose gold mirror stainless steel
Floor: PVC/Marble
Handrail: Titanium mirror stainless steel
COP: LG-CZ002
HOP: LG-WH001

侧壁: 钛金镜面蚀刻不锈钢+玫瑰金不锈钢
后壁: 钛金镜面蚀刻不锈钢+玫瑰金不锈钢
吊顶: 玫瑰金镜面不锈钢
地板: PVC/大理石
扶手: 钛金镜面不锈钢
操纵箱: LG-CZ002
外呼: LG-WH001



LG-K40

Side wall: Rose gold mirror stainless steel + Rose gold hairline stainless steel
Rear wall: Rose gold etched stainless steel + Rose gold mirror stainless steel
Ceiling: Rose gold mirror stainless steel + LED lights
Floor: PVC/Marble
Handrail: Wooden grain + Rose gold stainless steel
COP: LG-CZ002
HOP: LG-WH001

侧壁: 玫瑰金镜面不锈钢+玫瑰金发纹不锈钢
后壁: 玫瑰金蚀刻不锈钢+玫瑰金镜面不锈钢
吊顶: 玫瑰金镜面不锈钢+LED灯
地板: PVC/大理石
扶手: 木纹+玫瑰金不锈钢
操纵箱: LG-CZ002
外呼: LG-WH001



LG-K35

Side wall: Titanium mirror etched stainless steel + Titanium etched stainless steel
Rear wall: Titanium etched stainless steel + Titanium hairline stainless steel
Ceiling: Titanium mirror stainless steel + LED lights
Floor: PVC/Marble
Handrail: Titanium stainless steel
COP: LG-CZ002
HOP: LG-WH001

侧壁: 钛金镜面蚀刻不锈钢+钛金蚀刻不锈钢
后壁: 钛金蚀刻不锈钢+钛金发纹不锈钢
吊顶: 钛金镜面不锈钢+LED灯
地板: PVC/大理石
扶手: 钛金不锈钢
操纵箱: LG-CZ002
外呼: LG-WH001



LG-K36

Side wall: Titanium mirror stainless steel + Titanium etched stainless steel
Rear wall: Titanium mirror stainless steel + Titanium etched stainless steel
Ceiling: Titanium mirror stainless steel + LED lights
Floor: PVC/Marble
Handrail: Wooden grain + Titanium stainless steel
COP: LG-CZ002
HOP: LG-WH001

侧壁: 钛金镜面不锈钢+钛金蚀刻不锈钢
后壁: 钛金镜面不锈钢+钛金蚀刻不锈钢
吊顶: 钛金镜面不锈钢+LED灯
地板: PVC/大理石
扶手: 木纹+钛金不锈钢
操纵箱: LG-CZ002
外呼: LG-WH001



LG-K41

Side wall: Rose gold mirror etched stainless steel + Rose gold hairline stainless steel
Rear wall: Rose gold mirror etched stainless steel + Rose gold hairline stainless steel
Ceiling: Rose gold mirror stainless steel + LED lights
Floor: PVC/Marble
Handrail: Rose gold stainless steel
COP: LG-CZ002
HOP: LG-WH001

侧壁: 玫瑰金镜面蚀刻不锈钢+玫瑰金发纹不锈钢
后壁: 玫瑰金镜面蚀刻不锈钢+玫瑰金发纹不锈钢
吊顶: 玫瑰金镜面不锈钢+LED灯
地板: PVC/大理石
扶手: 玫瑰金不锈钢
操纵箱: LG-CZ002
外呼: LG-WH001



LG-K42

Side wall: Rose gold mirror etched stainless steel + Rose gold hairline stainless steel
Rear wall: Rose gold mirror etched stainless steel + Rose gold hairline stainless steel
Ceiling: Rose gold mirror stainless steel + LED lights
Floor: PVC/Marble
Handrail: Rose gold stainless steel
COP: LG-CZ002
HOP: LG-WH001

侧壁: 玫瑰金镜面蚀刻不锈钢+玫瑰金发纹不锈钢
后壁: 玫瑰金镜面蚀刻不锈钢+玫瑰金发纹不锈钢
吊顶: 玫瑰金镜面不锈钢+LED灯
地板: PVC/大理石
扶手: 玫瑰金不锈钢
操纵箱: LG-CZ002
外呼: LG-WH001



LG-K37

Side wall: Titanium mirror etched stainless steel
Rear wall: Titanium mirror etched stainless steel
Ceiling: Titanium mirror stainless steel + LED lights
Floor: PVC/Marble
Handrail: Wooden grain + Titanium stainless steel
COP: LG-CZ002
HOP: LG-WH001

侧壁: 钛金镜面蚀刻不锈钢
后壁: 钛金镜面蚀刻不锈钢
吊顶: 钛金镜面不锈钢+LED灯
地板: PVC/大理石
扶手: 木纹+钛金不锈钢
操纵箱: LG-CZ002
外呼: LG-WH001



LG-K38

Side wall: Titanium mirror etched stainless steel + Titanium mirror stainless steel
Rear wall: Titanium mirror etched stainless steel + Titanium mirror stainless steel
Ceiling: Titanium mirror stainless steel+LED lights
Floor: PVC/Marble
Handrail: Titanium stainless steel
COP: LG-CZ002
HOP: LG-WH001

侧壁: 钛金镜面蚀刻不锈钢+钛金镜面不锈钢
后壁: 钛金镜面蚀刻不锈钢+钛金镜面不锈钢
吊顶: 钛金镜面不锈钢+LED灯
地板: PVC/大理石
扶手: 钛金不锈钢
操纵箱: LG-CZ002
外呼: LG-WH001



LG-K43

Side wall: Wooden grain + Mirror stainless steel
Rear Wall: Wooden grain + Mirror etched stainless steel
Ceiling: Mirror stainless steel + LED lights
Floor: PVC/Marble
Handrail: Single tube mirror
COP: LG-CZ002
HOP: LG-WH001

侧壁: 木纹钢板+镜面不锈钢
后壁: 木纹钢板+镜面蚀刻不锈钢
吊顶: 镜面不锈钢+LED灯
地板: PVC/大理石
扶手: 单管镜面
操纵箱: LG-CZ002
外呼: LG-WH001



LG-K44

Side wall: Mirror stainless steel + Wooden grain
Rear wall: Wooden grain
Ceiling: Mirror stainless steel + LED lights
Floor: PVC/Marble
Handrail: Single tube mirror
COP: LG-CZ002
HOP: LG-WH001

侧壁: 镜面不锈钢+木纹钢板
后壁: 木纹钢板
吊顶: 镜面不锈钢+LED灯
地板: PVC/大理石
扶手: 单管镜面
操纵箱: LG-CZ002
外呼: LG-WH001

CONSTRUCTION LAYOUT DRAWING

Small Machine Room Passenger Elevator

小机房乘客电梯土建参数

Shaft elevational drawing

井道立面图

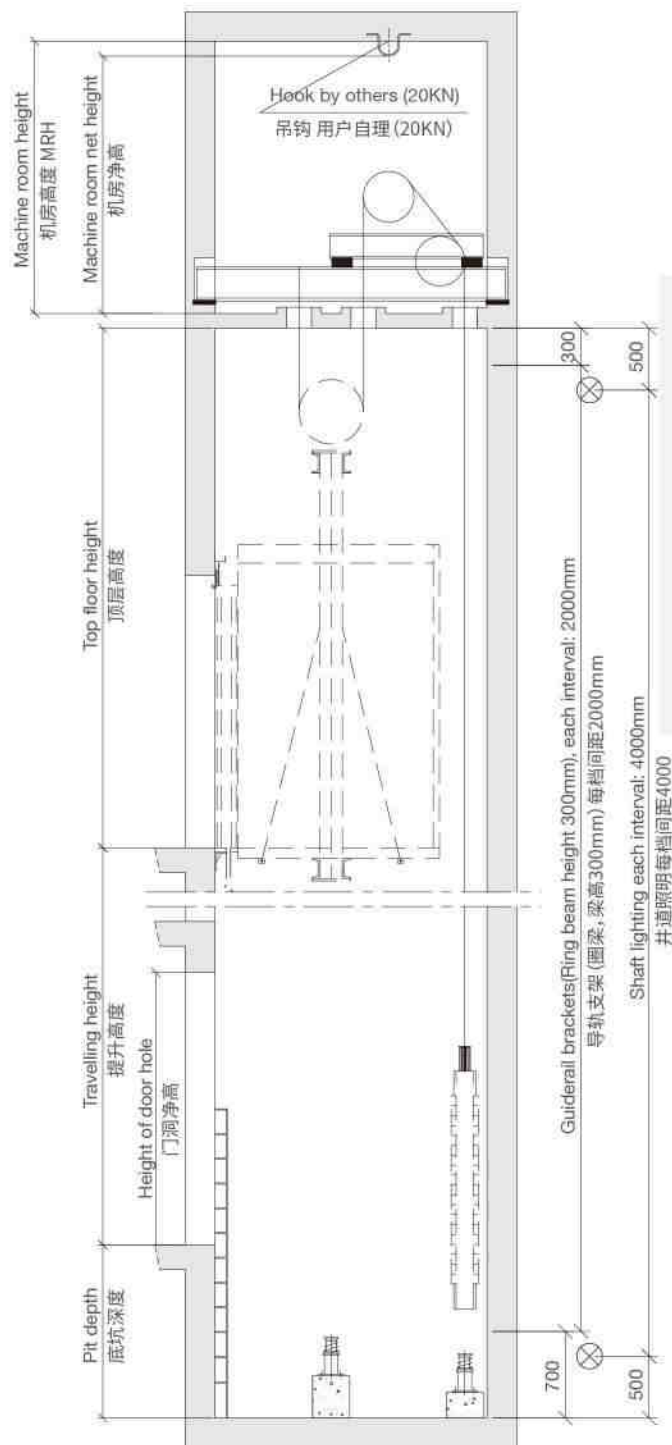

Machine room plane layout

机房平面布置图

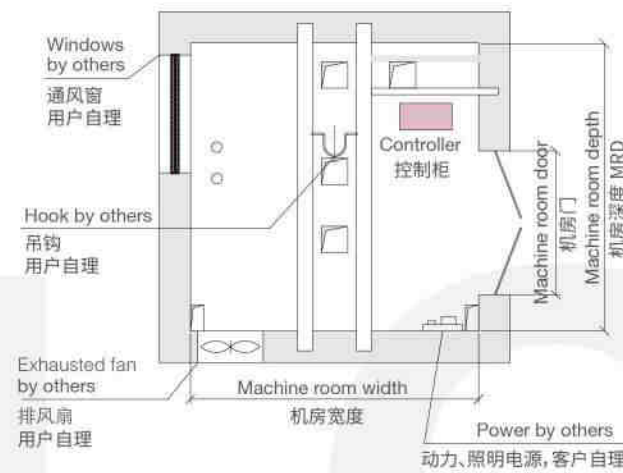

Shaft plane layout

井道平面布置图

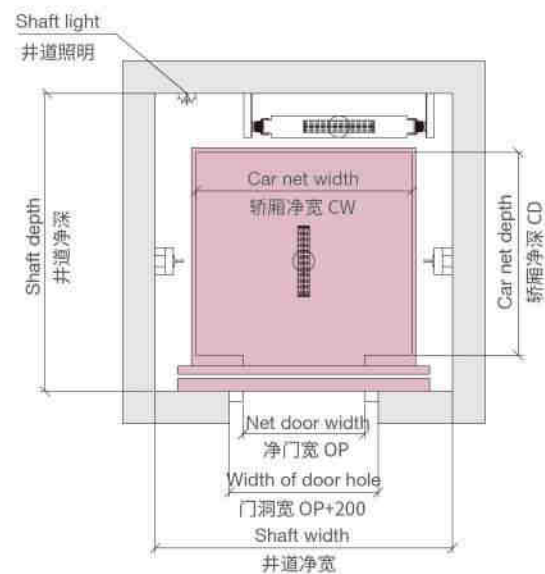

Small machine room passenger elevator parameters

小机房乘客电梯参数表

Load(kg) 载重(kg)	Speed (m/s) 速度	Car dimension (mm) 轿厢尺寸(mm)	Door-opening size(mm) 开门尺寸(mm)	Shaft size (mm) 井道尺寸(mm)	Machine room size (mm) 机房尺寸(mm)	Overhead height (OH) 顶层高度	Pit depth (PD) 底坑深度
		Inner size AXB 内尺寸AXB	Net door-opening 净开门C	Width x depth 宽 x 深	Width x depth 宽 x 深		
450	1.0	1100x1100	800	1600x1650	1600x1650	4000	1500
	1.5					4500	1500
	1.75					4500	1500
630	1.0	1400x1100	800	2000x1800	2000x1800	4500	1500
	1.5					4600	1600
	1.75					4700	1700
	2.0					4800	2000
800	1.0	1400x1350	800	2000x2000	2000x2000	4500	1500
	1.5					4600	1600
	1.75					4700	1700
1000	1.0	1600x1500	900	2200x2200	2200x2200	4500	1500
	1.5					4600	1600
	1.75					4700	1700
1250	1.0	1800x1550	1100	2400x2300	2400x2300	4500	1500
	1.5					4600	1600
	1.75					4700	1700
1350	1.0	1900x1600	1100	2500x2350	2500x2350	4500	1500
	1.5					4600	1600
	1.75					4700	1700
1600	1.0	1950x1700	1100	2600x2450	2600x2450	4500	1500
	1.5					4600	1600
	1.75					4700	1700
	2.0					4800	2000

The data is for design reference only. For the detailed parameters, please take the technical drawing as the criterion.
(本资料仅供设计选用参考, 详细参数以技术图纸为准。)

CONSTRUCTION LAYOUT DRAWING

Machine Roomless Passenger Elevator 无机房乘客电梯土建参数

Shaft elevational drawing

井道立面图

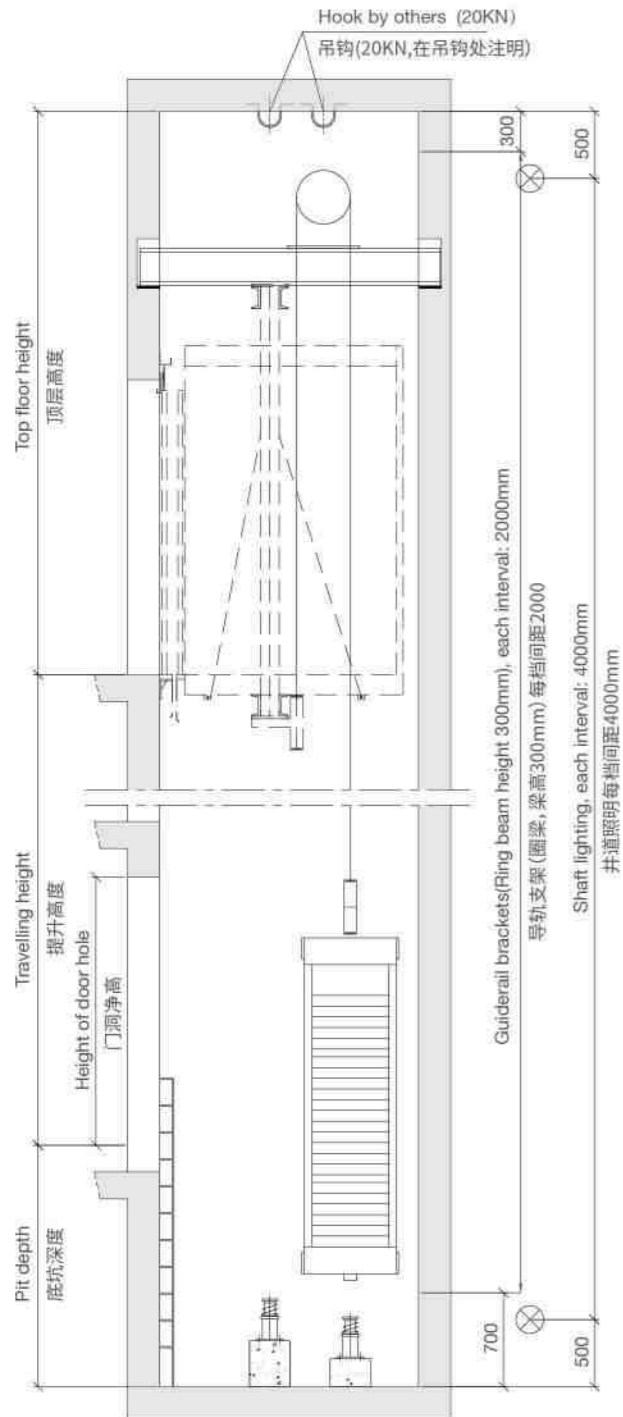

Overhead plane layout

顶层平面布置图

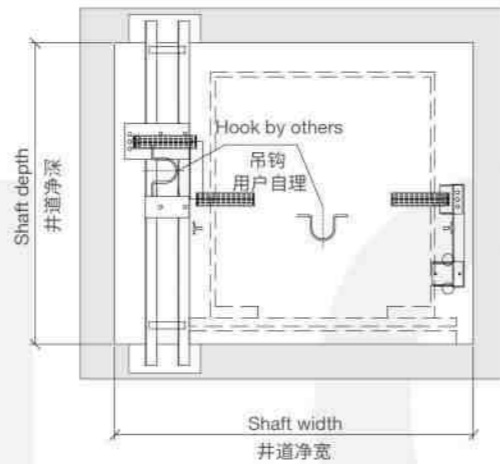

Shaft plan layout

井道平面布置图

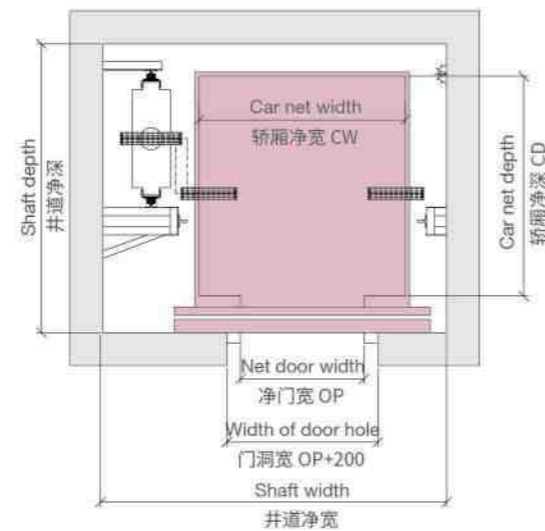

Overhead plane layout

顶层平面布置图

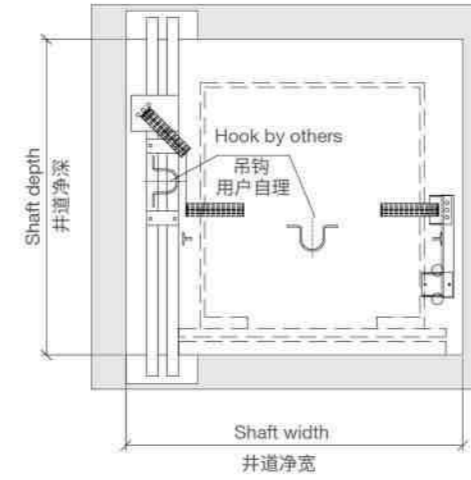

Shaft plan layout

井道平面布置图

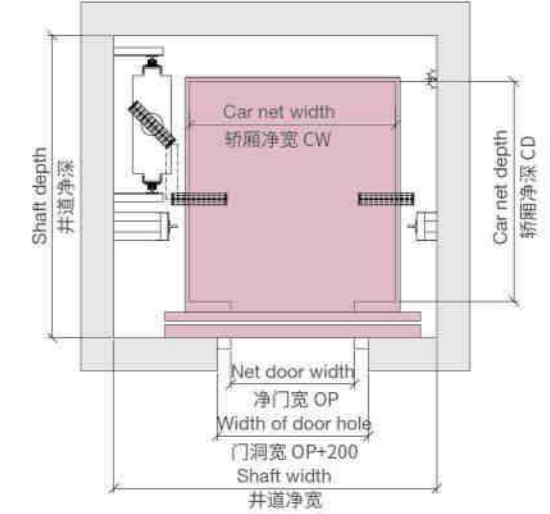

Machine roomless passenger elevator parameters

无机房乘客电梯参数表

Load (kg) 载重 (kg)	Speed 速度 (m/s)	Car dimension (mm) 轿厢尺寸 (mm)	Door-opening size (mm) 开门尺寸 (mm)	Shaft size (mm) 井道尺寸 (mm)	Overhead height 顶层高度 (OH)	Pit depth 底坑深度 (PD)
		Inner size AXB 内尺寸 AXB	Net door-opening 净开门 C	Width x depth 宽 x 深		
450	1.0	1100×1100	800	1900×1600	4200	1500
	1.5				4500	1600
	1.75				4500	1700
630	1.0	1400×1100	800	2250×1700	4500	1600
	1.5				4700	1700
	1.75				4700	1900
	2.0				4900	2000
800	1.0	1400×1350	800	2250×1800	4500	1600
	1.5				4700	1700
	1.75				4700	1900
	2.0				4900	2000
1000	1.0	1600×1500	900	2450×2000	4500	1600
	1.5				4700	1700
	1.75				4700	1900
	2.0				4900	2000
1250	1.0	1800×1550	1100	2750×2050	4600	1600
	1.5				4700	1700
	1.75				4700	1900
	2.0				4900	2000
1350	1.0	1900×1600	1100	2850×2050	4700	1600
	1.5				4900	1700
	1.75				4900	1800
	2.0				5000	2000
1600	1.0	1950×1700	1100	2950×2200	4700	1700
	1.5				4900	1800
	1.75				4900	1800
	2.0				5000	2000

The data is for design reference only. For the detailed parameters, please take the technical drawing as the criterion.
(本资料仅供设计选用参考,详细参数以技术图纸为准。)

PANORAMIC ELEVATOR

观光电梯

Panoramic elevator, a new kind of elevator which not only for loading people from one floor to another floor. It brings people sightseeing experiences when they use, and becomes a nice view in the place.

观光电梯,一种新类型的电梯,不只是承载人们从一层到达另外一层,也在这个过程中给人们带来更多的观光体验,而它本身也成为一道亮丽的风景。



Semicircle Type Panoramic Elevator

半圆形观光电梯

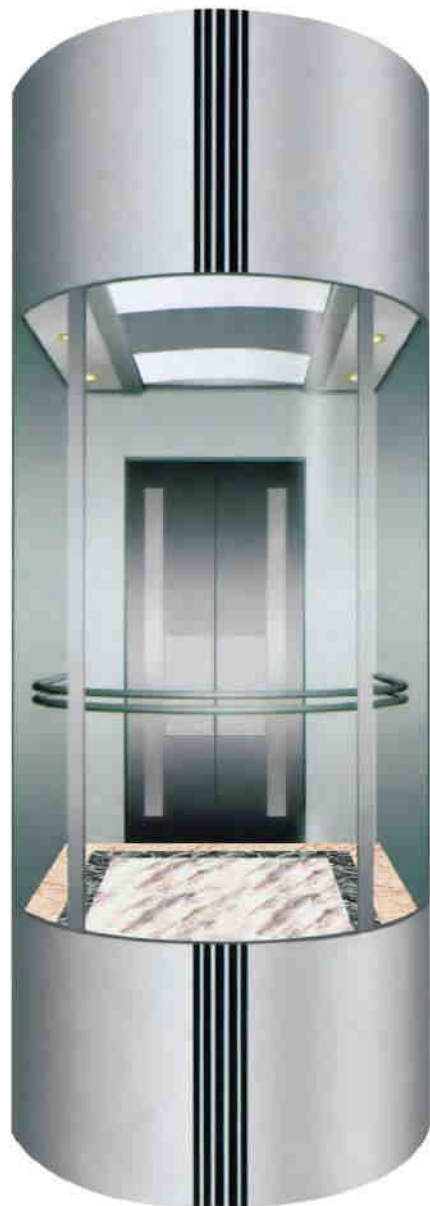

LG-GY01

(Standard 标配)

Car cover: Steel plate baking finish
Observation wall: Laminated glass
Decoration roof: LG-D19
Car wall: Hairline stainless steel
Handrail: Stainless steel pair tube
Floor: PVC/Marble

上下罩: 钢板烤漆
观光壁: 安全夹胶玻璃
装饰顶: LG-D19
轿壁: 发纹不锈钢
扶手: 不锈钢双管
地板: PVC/大理石



LG-D19

Central image arch, stainless steel base plate is supplemented with soft lighting design of down lamp at both sides.

中部是影像拱顶, 两侧为不锈钢底板上辅以筒灯的柔光照明设计。



LG-HG04

Pair stainless steel tube for handrail
不锈钢双联圆管扶手



LG-F13

PVC/Marble
PVC/大理石

Exquisite Car

精美轿厢

Different styles, elegant and beautiful elevator decoration scheme, can perfectly match all kinds of building appearance and interior decoration.

风格迥异、典雅美观的轿厢装潢方案,可以完美匹配各类大楼外观和内部装潢。



Square Type Panoramic Elevator

方形观光电梯



LG-GF01

(Standard 标配)

Car cover: Steel plate baking finish, acrylic lighting decoration
Observation wall: Square, glue glass of safety clamp
Decoration roof: LG-D04
Car wall: Hairline stainless steel
Handrail: Single tube mirror
Floor: PVC/Marble

上下罩: 钢板烤漆, 配亚克力灯饰
观光壁: 方形, 安全夹胶玻璃
装饰顶: LG-D04
轿壁: 发纹不锈钢
扶手: 单管镜面
地板: PVC/大理石



LG-D04

Stainless steel mirror base plate is supplemented with down lamp and car wall. Central part consists of soft lighting design of white light-emitting panel. ral part consists of soft lighting design of arched white light-emitting panel.

在镜面不锈钢底板上辅以筒灯与轿壁辉映, 中间部分是白色透光板的柔光照明设计。



LG-H01

Single tube mirror
单管镜面



LG-F04

PVC/Marble
PVC/大理石

PANORAMIC ELEVATOR (SEMICIRCLE TYPE)

观光电梯(半圆形)



LG-GY02

Car cover: Mirror etching
Observation wall: 3PCS of Safety laminated glass
Decoration roof: LG-D18
Car wall: Hairline, mirror, etched, titanium
Floor: PVC/Marble
Handrail: Stainless steel single tube
COP: LG-CZ002
HOP: LG-WH001

上下罩: 镜面蚀刻
观光壁: 安全夹胶玻璃三块
装饰顶: LG-D18
轿壁: 发纹、镜面、蚀刻、钛金
地板: PVC/大理石
扶手: 不锈钢单管
操纵箱: LG-CZ002
外呼: LG-WH001



LG-GY03

Car cover: Steel plate baking paint plus stainless steel hoarding and decorative lights
Observation wall: 3PCS of Safety laminated glass
Decoration roof: LG-D16
Car wall: Hairline, etching
Floor: PVC/Marble
Handrail: Stainless steel single tube
COP: LG-CZ002
HOP: LG-WH001

上下罩: 钢板烤漆加不锈钢围板及装饰灯
观光壁: 安全夹胶玻璃三块
装饰顶: LG-D16
轿壁: 发纹板、蚀刻
地板: PVC/大理石
扶手: 不锈钢单管
操纵箱: LG-CZ002
外呼: LG-WH001



LG-GY04

Car cover: Mirror stainless steel
Observation wall: 3PCS of Safety laminated glass
Decoration roof: LG-D13
Car wall: Mirror stainless steel
Floor: PVC/Marble
Handrail: Mirror stainless steel single tube
COP: LG-CZ002
HOP: LG-WH001

上下罩: 镜面不锈钢
观光壁: 安全夹胶玻璃三块
装饰顶: LG-D13
轿壁: 镜面不锈钢
地板: PVC/大理石
扶手: 镜面不锈钢单管
操纵箱: LG-CZ002
外呼: LG-WH001



LG-GY05

Car cover: Steel plate spray paint and decorative lights
Observation wall: 3PCS of Safety laminated glass
Decoration roof: LG-D17
Car wall: Hairline, etching
Floor: PVC/Marble
Handrail: Mirror stainless steel single tube
COP: LG-CZ002
HOP: LG-WH001

上下罩: 钢板喷漆加装饰灯
观光壁: 安全夹胶玻璃三块
装饰顶: LG-D17
轿壁: 发纹板、蚀刻
地板: PVC/大理石
扶手: 镜面不锈钢单管
操纵箱: LG-CZ002
外呼: LG-WH001



LG-GY06

Car cover: Steel plate spraying paint and acrylic dome cover
Observation wall: 3PCS of Safety laminated glass
Decoration roof: LG-D15
Car wall: Stainless steel hairline plate
Floor: PVC/Marble
Handrail: Stainless steel double tube
COP: LG-CZ002
HOP: LG-WH001

上下罩: 钢板喷涂加亚克力球罩
观光壁: 安全夹胶玻璃三块
装饰顶: LG-D15
轿壁: 不锈钢发纹板
地板: PVC/大理石
扶手: 不锈钢双管
操纵箱: LG-CZ002
外呼: LG-WH001



LG-GY07

Car cover: Steel plate spraying
Observation wall: 3PCS of Safety laminated glass
Decoration roof: LG-D14
Car wall: Stainless steel hairline plate
Floor: PVC/Marble
Handrail: Stainless steel double tube
COP: LG-CZ002
HOP: LG-WH001

上下罩: 钢板喷涂
观光壁: 安全夹胶玻璃三块
装饰顶: LG-D14
轿壁: 不锈钢发纹板
地板: PVC/大理石
扶手: 不锈钢双管
操纵箱: LG-CZ002
外呼: LG-WH001

PANORAMIC ELEVATOR (SQUARE TYPE)

观光电梯(方形)



LG-GF02

Car cover: Steel plate spraying and decorative light
Observation wall: Safety laminated glass
Decoration roof: LG-D10
Car wall: Hairline board
Floor: PVC/Marble
Handrail: Stainless steel single tube
COP: LG-CZ002
HOP: LG-WH001

上下罩: 钢板喷漆加装饰灯
观光壁: 安全夹胶玻璃
装饰顶: LG-D10
轿壁: 发纹板
地板: PVC/大理石
扶手: 不锈钢单管
操纵箱: LG-CZ002
外呼: LG-WH001



LG-GF03

Car cover: Steel plate spraying and decorative light
Observation wall: Safety laminated glass
Decoration roof: LG-D04
Car wall: Hairline board
Floor: PVC/Marble
Handrail: Stainless steel single tube
COP: LG-CZ002
HOP: LG-WH001

上下罩: 钢板喷漆加装饰灯
观光壁: 安全夹胶玻璃
装饰顶: LG-D04
轿壁: 发纹板
地板: PVC/大理石
扶手: 不锈钢单管
操纵箱: LG-CZ002
外呼: LG-WH001



LG-GF04

Car cover: Ladder pentagon steel plate with paint and decorative light
Observation wall: Safety laminated glass
Decoration roof: Central round acrylic ceiling light, down light
Car wall: Stainless steel hairline plate
Floor: PVC/Marble
Handrail: Stainless steel single tube
COP: LG-CZ002
HOP: LG-WH001

上下罩: 阶梯五边形钢板烤漆+装饰灯
观光壁: 安全夹胶玻璃
装饰顶: 中部圆形亚克力顶灯, 筒灯
轿壁: 不锈钢发纹板
地板: PVC/大理石
扶手: 不锈钢单管
操纵箱: LG-CZ002
外呼: LG-WH001



LG-GF05

Car cover: Steel plate spraying
Observation wall: Safety laminated glass
Decoration roof: Mirror stainless steel, LED lights
Car wall: Safety laminated glass
Floor: PVC/Marble
Handrail: Stainless steel single tube
COP: LG-CZ002
HOP: LG-WH001

上下罩: 钢板喷漆
观光壁: 安全夹胶玻璃
装饰顶: 镜面不锈钢, LED灯
轿壁: 安全夹胶玻璃
地板: PVC/大理石
扶手: 不锈钢单管
操纵箱: LG-CZ002
外呼: LG-WH001



LG-GF06

Car cover: Steel plate spraying and decorative light
Observation wall: Safety laminated glass
Decoration roof: Mirror stainless steel, LED lights
Car wall: Stainless steel hairline plate
Floor: PVC/Marble
Handrail: Stainless steel single tube
COP: LG-CZ002
HOP: LG-WH001

上下罩: 钢板喷漆加装饰灯
观光壁: 安全夹胶玻璃
装饰顶: 镜面不锈钢, LED灯
轿壁: 发纹板
地板: PVC/大理石
扶手: 不锈钢单管
操纵箱: LG-CZ002
外呼: LG-WH001



LG-GF07

Car cover: Painted steel sheet, spotlight
Observation wall: 6+6 Safety laminated glass three pieces
Decoration roof: Mirror stainless steel, LED lights
Car wall: Hairline stainless steel
Floor: PVC/Marble
Handrail: Stainless steel three tubes
COP: LG-CZ002
HOP: LG-WH001

上下罩: 钢板烤漆, 聚光灯
观光壁: 6+6安全夹胶玻璃三块
装饰顶: 镜面不锈钢, LED灯
轿壁: 发纹不锈钢
地板: PVC/大理石
扶手: 不锈钢三管
操纵箱: LG-CZ002
外呼: LG-WH001

CONSTRUCTION LAYOUT DRAWING

Small Machine Room Panoramic Elevator 小机房观光电梯土建参数

Square type shaft elevational drawing
方形井道立面图

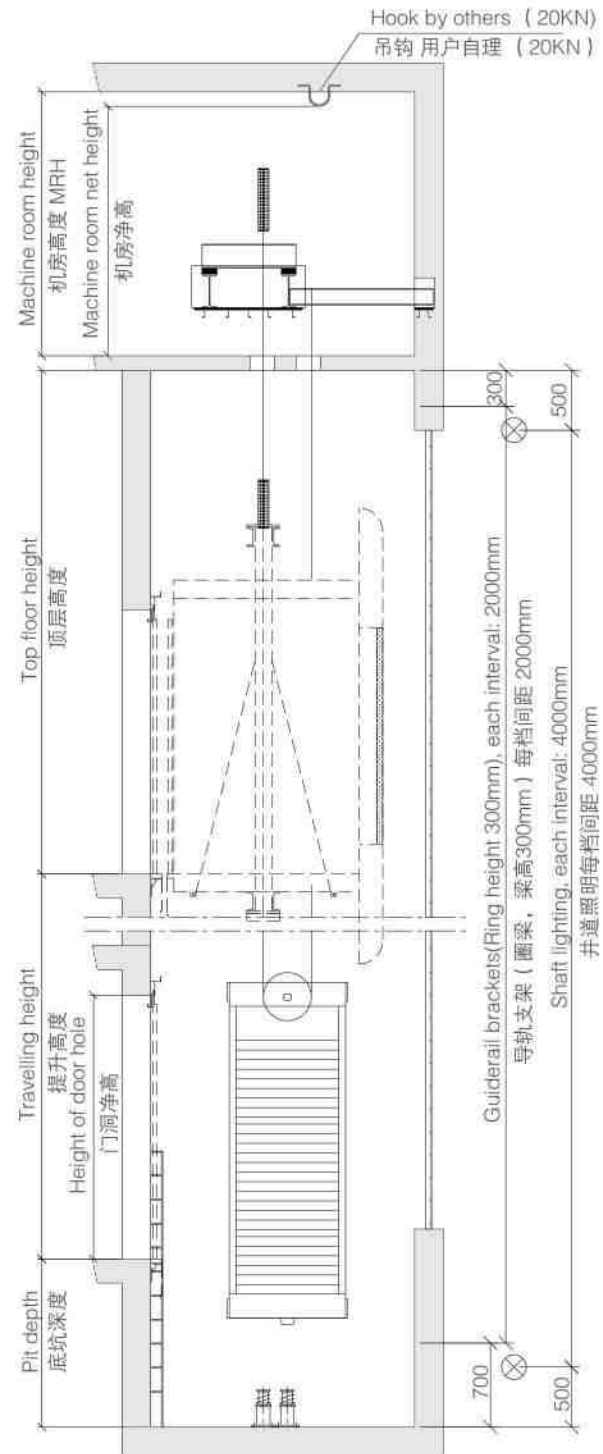

Semicircle type shaft elevational drawing
半圆形井道立面图

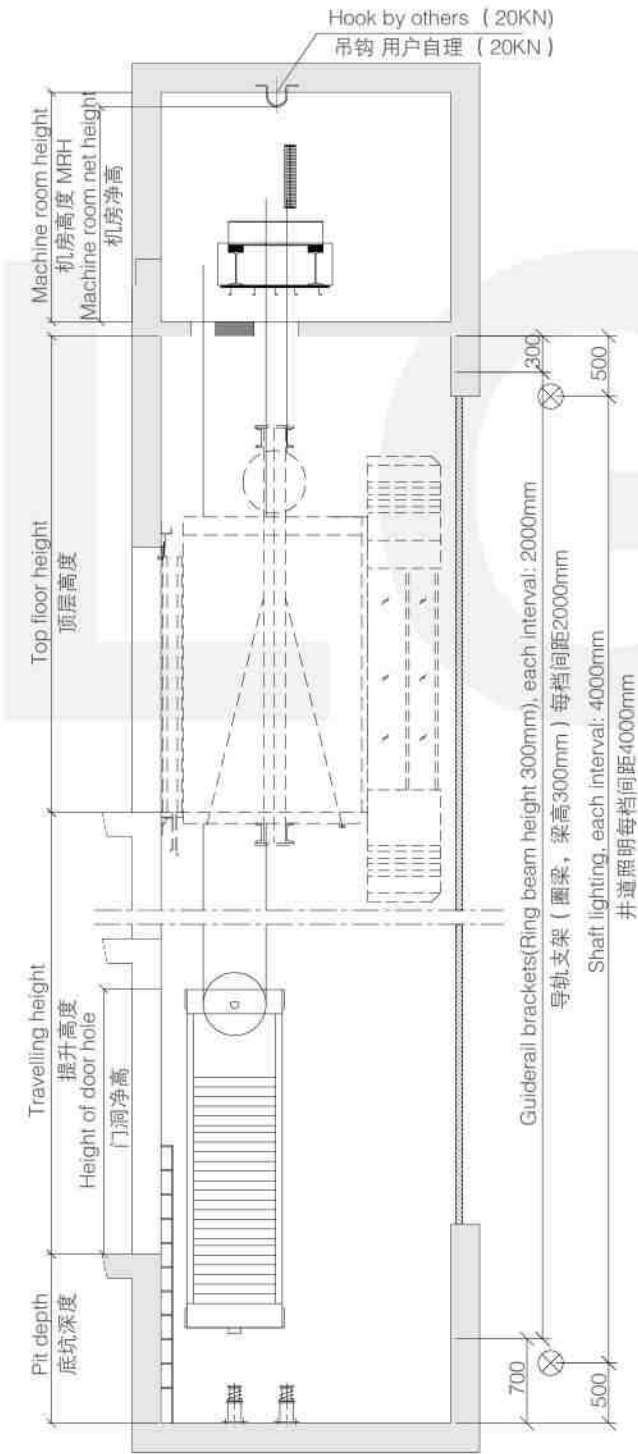

Square type machine room planform
方形机房平面布置图

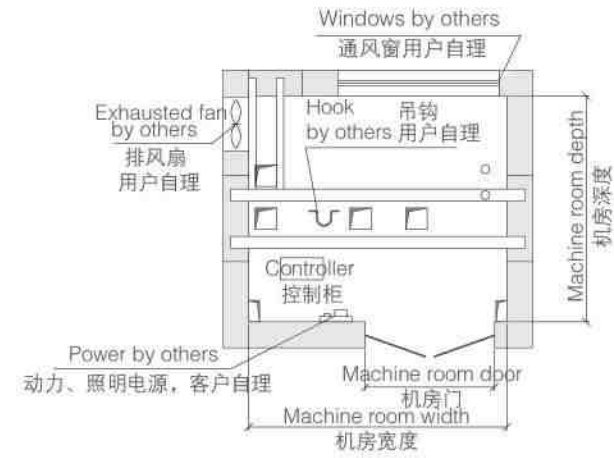

Semicircle type machine room planform
半圆形机房平面布置图

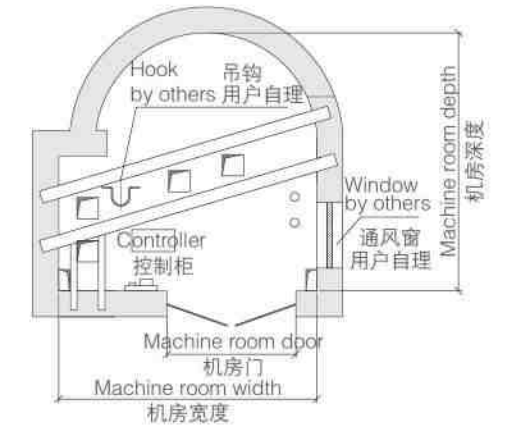

Square type shaft plan layout
方形井道平面布置图

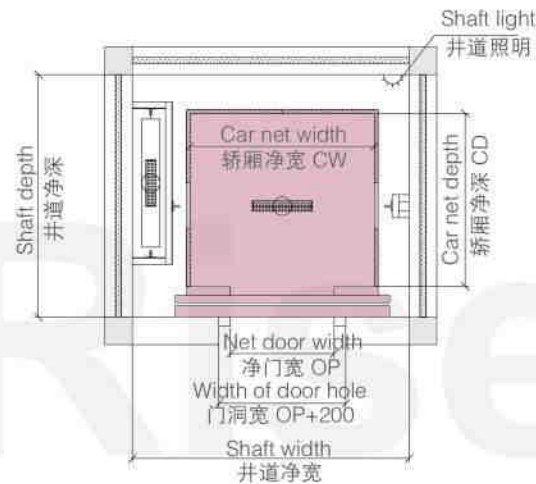

Semicircle type shaft plan layout
半圆形井道平面布置图

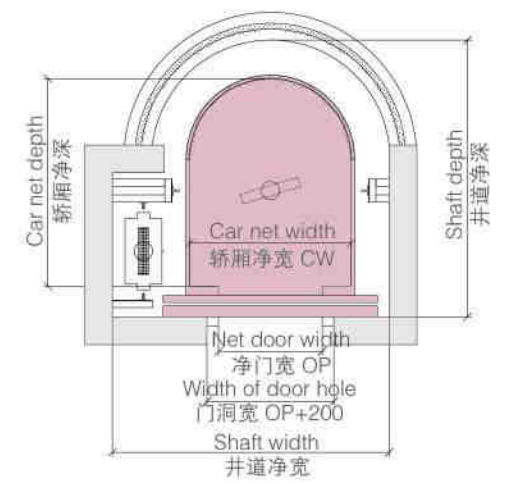

Small machine room panoramic elevator construction parameters
小机房观光电梯土建参数

Rated capacity 额定载重 (kg)	Rated Speed 额定速度 (m/s)	Door Opening Size 开门尺寸 (mm)	Car Size 轿厢尺寸 (mm)	Shaft Size 井道尺寸 (mm)	Overhead height 顶层高度 (OH)	Pit depth 底坑深度 (PD)
630	1.0	800×2100	1400×1100	2250×1750	4500	1600
	1.5				4500	1700
	1.75				4500	1800
800	1.0	800×2100	1350×1400	2200×1800	4500	1800
	1.5				4600	1800
	1.75				4800	1800
1000	1.0	900×2100	1400×1600	2400×1800	4500	1800
	1.5				4600	1800
	1.75				4800	1800

The data is for design reference only. For the detailed parameters, please take the technical drawing as the criterion.
(本资料仅供设计选用参考, 详细参数以技术图纸为准。)

CONSTRUCTION LAYOUT DRAWING

Machine Roomless Panoramic Elevator 无机房观光电梯土建参数

Square type shaft elevational drawing
方形井道立面图

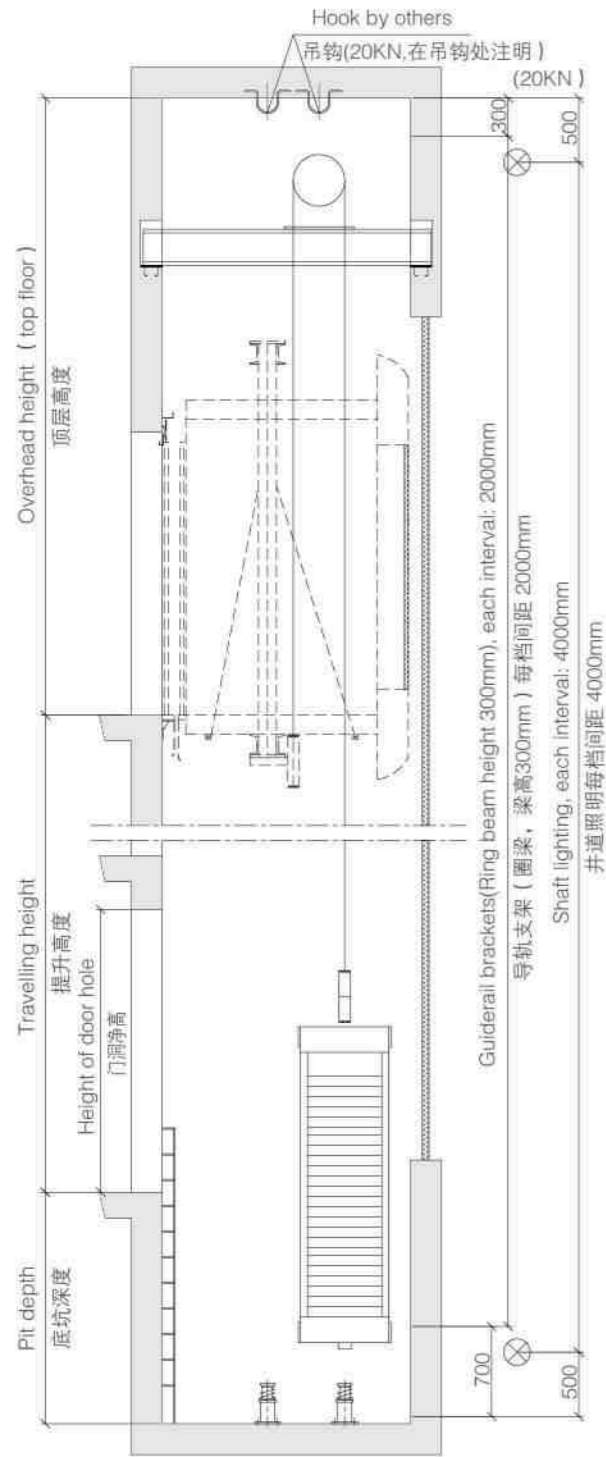

Semicircle type shaft elevational drawing
半圆形井道立面图

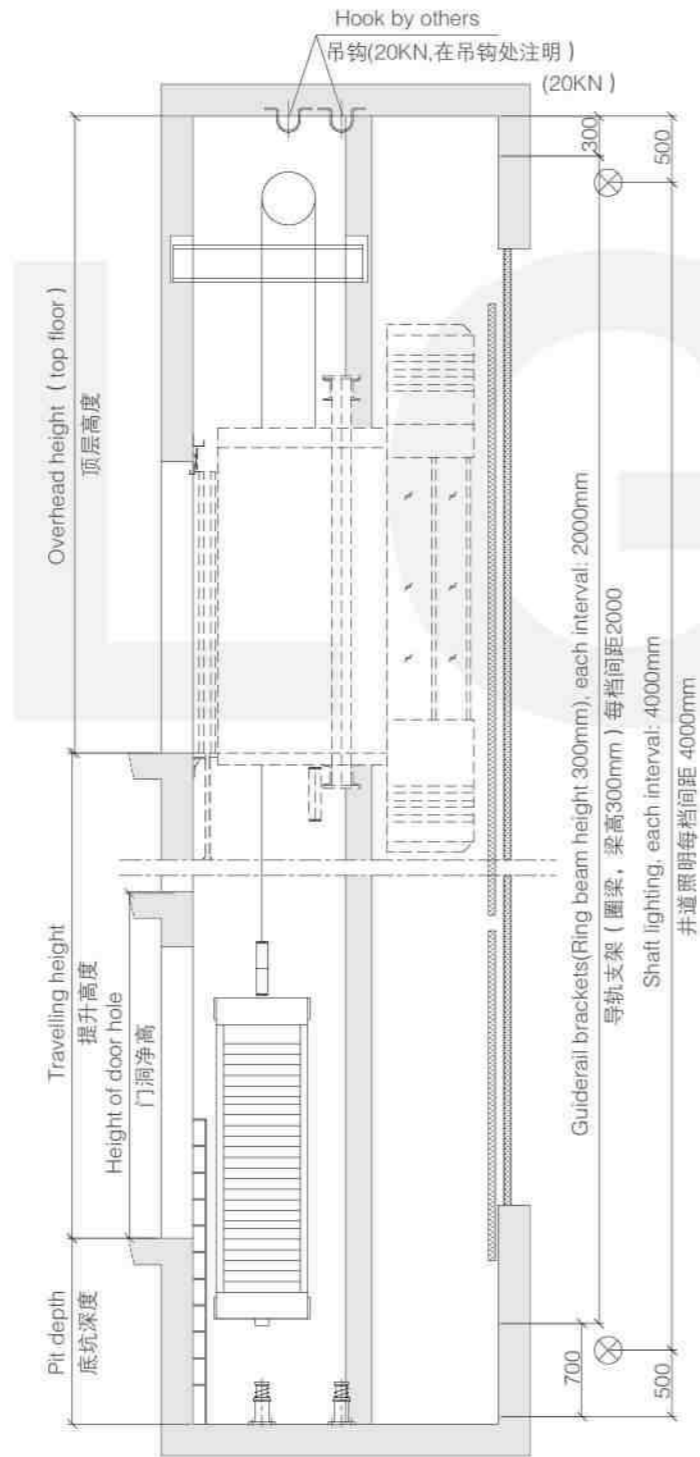

Square type top plan layout
方形顶层平面布置图

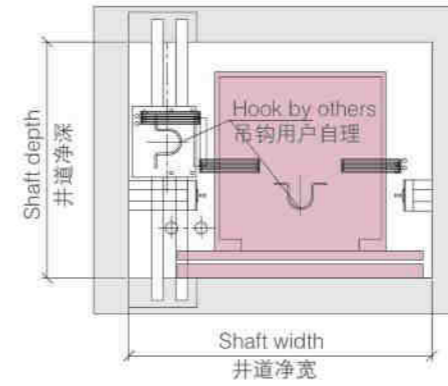

Semicircle type top plan layout
半圆形顶层平面布置图

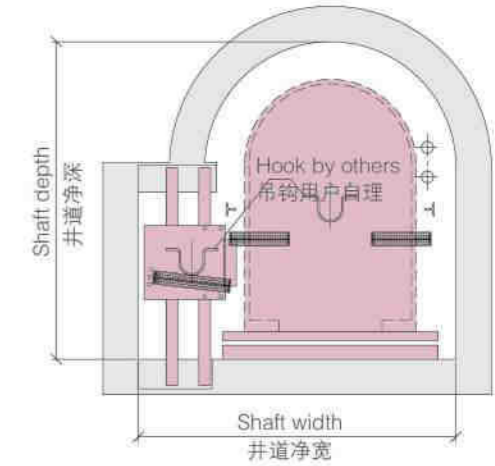

Square type shaft plan layout
方形井道平面布置图

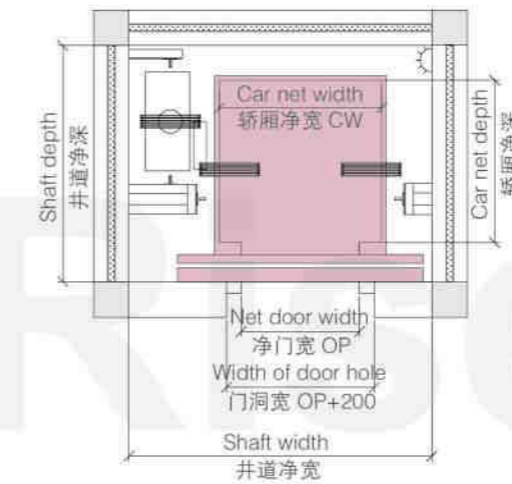

Semicircle type shaft plan layout
半圆形井道平面布置图

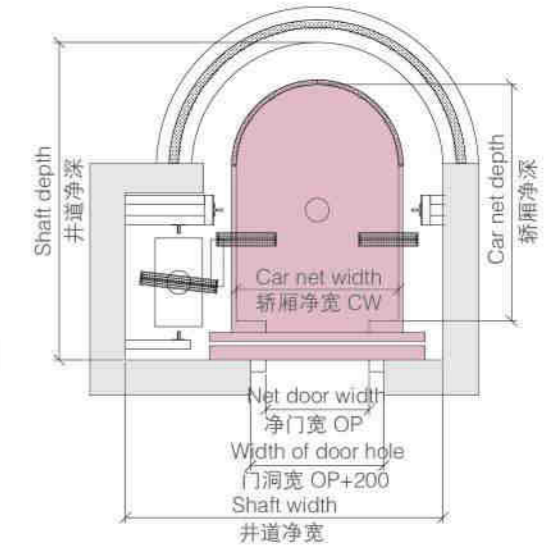

Machine roomless panoramic elevator construction parameters
无机房观光电梯土建参数

Rated capacity 额定载重 (kg)	Rated Speed 额定速度 (m/s)	Door Opening Size 开门尺寸(mm)	Car Size 轿厢尺寸 (mm)	Shaft Size 井道尺寸 (mm)	Overhead height 顶层高度(OH)	Pit depth 底坑深度 (PD)
630	1.0	800x2100	1400x1100	2300x1700	4500	1600
	1.5				4500	1700
	1.75				4500	1800
800	1.0	800x2100	1200x1700	2300x2300	4600	1600
	1.75				4700	1750
1000	1.0	900x2100	1400x1850	2500x2450	4600	1600
	1.75				4700	1750

The data is for design reference only. For the detailed parameters, please take the technical drawing as the criterion.
(本资料仅供设计选用参考,详细参数以技术图纸为准。)

HOSPITAL ELEVATOR

医用电梯

Hospital elevators are one of the supporting medical facilities provided to hospitals, modern chemical centers, nursing homes, health hospitals, etc., mainly used to transport passengers, bed, stretchers and medical equipment. Hospital elevators are a special type of elevator. Special and strict requirements for their functional performance. LG hospital elevators, there is a larger car space, more stable operating performance, transport the passengers to the destination floor quickly, comfortably, and safely.

医用电梯是专为医院、现代化医疗中心、疗养院、保健院等提供的配套医疗设施之一，主要用于运送乘客、病床担架和医疗器材；医用电梯是一种特殊梯种，因其使用环境的特殊而对其功用性能有着严格要求。LG医用电梯，有更大的轿厢空间，更加平稳的运行性能，将乘客快速、舒适，且安全地运送到目的楼层。



Hospital Elevator Car

医用电梯轿厢



Operation Panel For Disabled

残疾人操纵箱



(Standard 标配)

Ceiling: Hairline stainless steel,
fluorescent lighting, down lamp

Car wall: Hairline stainless steel

Handrail: Flat stainless steel

Floor: PVC floor

吊顶:发纹不锈钢, 日光灯照明, 筒灯

轿壁:发纹不锈钢

扶手:扁形不锈钢

地板:PVC地板

CONSTRUCTION LAYOUT DRAWING

Hospital Elevator

医用电梯土建参数

Shaft vertical section layout

井道立面布置图

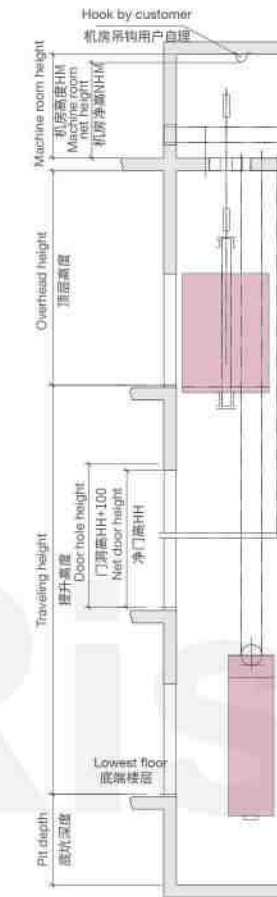

Machine room plan view

机房平面布置图

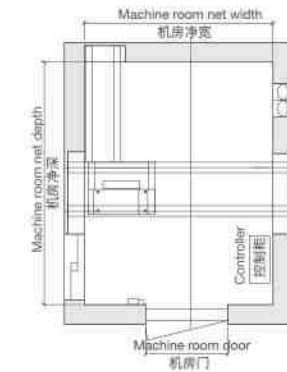

Shaft plane layout

井道平面布置图

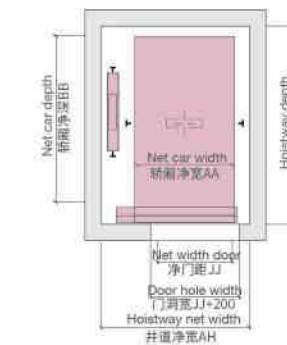

Hospital elevator construction parameters

医用电梯土建参数

Rated capacity (kg) 额定载重	Rated speed (m/s) 额定速度	Net size of car 轿厢净尺寸(mm)			Door opening 开门方式 center opening side opening 中分/旁开	Net door opening 开门净尺寸(mm)		Hoistway net size 井道净尺寸(mm)		Minimum pit depth (mm) 最小 层坑深度	Minimum top height (mm) 最小 顶层高度	Machine room net height (mm) 机房净高度
		Net width 净宽	Net depth 净深	Total height 总高		Net width 净宽	Net height 净高	Hoistway net width 井道净宽	Hoistway net depth 井道净深			
1600	1.0	1400	2400	2500	中分两扇门	1100	2100	2500	2800	1250	4000	2300
	1.75									1400	4200	
	2.0									1500	4500	
	2.5									1800	4800	
	3.0									2600	5500	
1600	1.0	1400	2400	2500	旁开两扇门	1100	2100	2250	2900	1250	4000	2300
	1.75									1400	4200	
	2.0									1500	4500	
	2.5									1800	4800	
	3.0									2600	5500	
2000	1.0	1500	2700	2500	中分两扇门	1200	2100	2650	3100	1250	4000	2300
	1.75									1400	4200	
	2.0									1500	4500	
	2.5									1800	4800	
	3.0									2600	5500	
2000	1.0	1500	2700	2500	旁开两扇门	1200	2100	2350	3200	1250	4000	2300
	1.75									1400	4200	
	2.0									1500	4500	
	2.5									1800	4800	
	3.0									2600	5500	

The data is for design reference only. For the detailed parameters, please take the technical drawing as the criterion.
(本资料仅供设计选用参考, 详细参数以技术图纸为准。)

FREIGHT ELEVATOR

载货电梯

Freight elevator, more and more popular using in buildings. It has big loading from 1000kg to 10000kg, most efficient machine for cargo loading.

载货电梯,因其大载重高效率的承载能力(从1000kg到10000kg),越来越被广泛用于各种建筑。



Machine Roomless Freight Elevator

无机房载货电梯

Adopt advanced PMSM gearless machine, saving deceleration device with large size, greatly saving space, improving arrangement in well of elevator, there is no need for extra increase in structure strength of building, there is no need for machine room, saving construction space, thus reducing greatly construction cost.

采用先进的永磁同步无齿轮曳引机,省去了体积较大的减速装置,大大节省了空间,改进了电梯井道内的布局方式,不需要额外增加建筑物的结构强度,不需要设置有机房,节约了建筑空间,从而大大降低了建筑成本。



Your Goods Transportation Expert

您的货物运输专家

- ◆ The worm-and-worm-wheel traction technology, and other advanced driving and feedback technologies, such as vector control and distance control, are used to make the elevator demonstrate perfect running quality.
- ◆ Realizing precise and stable leveling with lower noise, adopt highly intensive profile making for sturdy and durable use.
- ◆ Large door opening space, adopt multi-folds lift car door to achieve maximum width for door opening, which is convenient for ingress and egress of large goods.
- ◆ 采用蜗轮蜗杆曳引技术,全面采用矢量控制、距离控制等先进的驱动和反馈技术,使电梯运行质量达到完美境界。
- ◆ 平层准确、噪音更低、运行更平稳,采用高强度的型材制作,坚固耐用。
- ◆ 开门距大,采用多折式厅轿门,达到最大开门宽度,便于大货物的进出。

First choice for economic type freight

经济型货运的首选工具

Well is needed to finish integrated installation, reducing effectively construction space cost.

The design with no machine room is small and exquisite compared with traditional elevator, integrating flexibly into construction.

只需井道即可完成整体的安装,有效降低建筑空间成本。
无机房电梯设计较传统电梯更小巧,融入建筑更灵活。

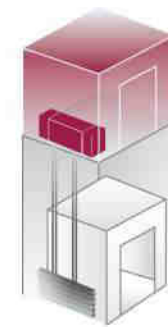

Traditional machine room freight elevator
传统机房货梯



Machine roomless freight elevator
无机房货梯



FREIGHT ELEVATOR

载货电梯

Side Opening 旁开门



LG-C01

(Standard 标配)

Car wall: Painted steel
 Car top: Painted steel
 Ventilation: Circular fan
 Car door: Painted steel
 Floor: Chequered plate steel
 Sill: Iron
 COP: LG-CZ002
 HOP: LG-WH001
 轿壁: 喷塑钢板
 轿顶: 喷塑钢板
 通风: 圆形风扇
 轿门: 喷塑钢板
 地板: 花纹钢板
 地坎: 铁
 操纵箱: LG-CZ002
 外呼: LG-WH001

Side opening [This is for reference only.]
 旁开式(仅供参考,以实物为准)

4-Panels Center Opening 中分门



LG-C03

(Optional 选配)

Car wall: Painted steel
 Car top: Painted steel
 Ventilation: Circular fan
 Car door: Painted steel
 Floor: Chequered plate steel
 Sill: Iron
 COP: LG-CZ002
 HOP: LG-WH001
 轿壁: 喷塑钢板
 轿顶: 喷塑钢板
 通风: 圆形风扇
 轿门: 喷塑钢板
 地板: 花纹钢板
 地坎: 铁
 操纵箱: LG-CZ002
 外呼: LG-WH001

2-Panels Center Opening 中分门

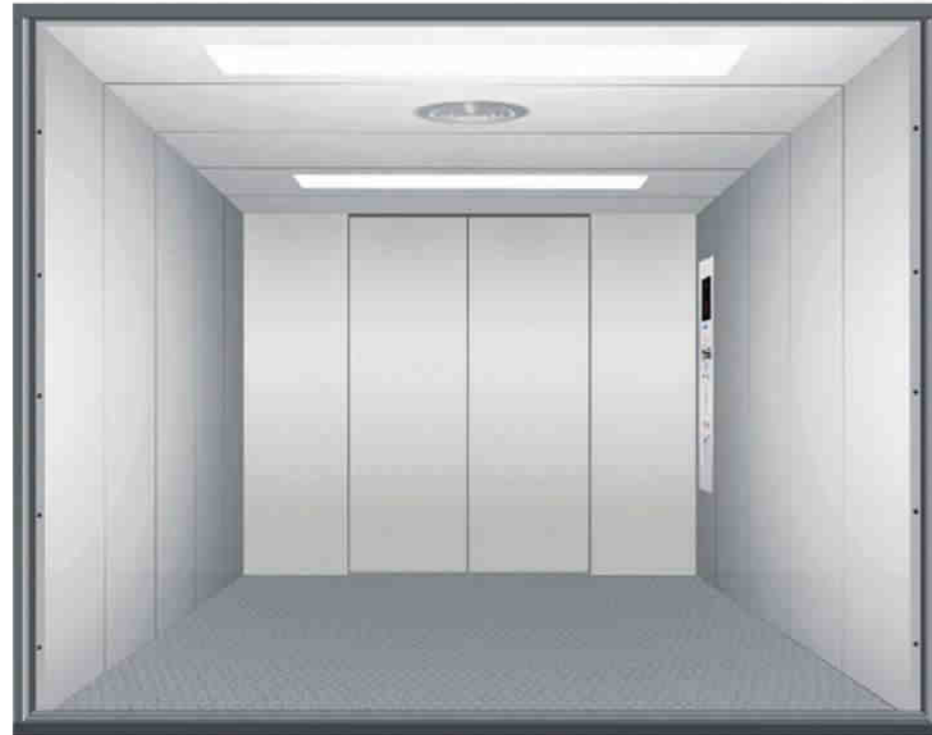

LG-C02

(Standard 标配)

Car wall: Painted steel
 Car top: Painted steel
 Ventilation: Circular fan
 Car door: Painted steel
 Floor: Chequered plate steel
 Sill: Iron
 COP: LG-CZ002
 HOP: LG-WH001
 轿壁: 喷塑钢板
 轿顶: 喷塑钢板
 通风: 圆形风扇
 轿门: 喷塑钢板
 地板: 花纹钢板
 地坎: 铁
 操纵箱: LG-CZ002
 外呼: LG-WH001

All Hairline Stainless Steel Finish



LG-C04

(Optional 选配)

Car wall: Hairline stainless steel
 Car top: Hairline stainless steel
 Ventilation: From car roof
 Car door: Hairline stainless steel
 Floor: Chequered plate steel
 Sill: Iron
 COP: LG-CZ002
 HOP: LG-WH001
 轿壁: 发纹不锈钢
 轿顶: 发纹不锈钢
 通风: 轿顶通风
 轿门: 发纹不锈钢
 地板: 花纹钢板
 地坎: 铁
 操纵箱: LG-CZ002
 外呼: LG-WH001

Freight Elevator Cabins
 载货电梯轿厢

CONSTRUCTION LAYOUT DRAWING

Freight Elevator With Machine Room 有机房载货电梯土建参数

Machine Roomless Freight Elevator 无机房载货电梯土建参数

Shaft elevational drawing
井道立面图

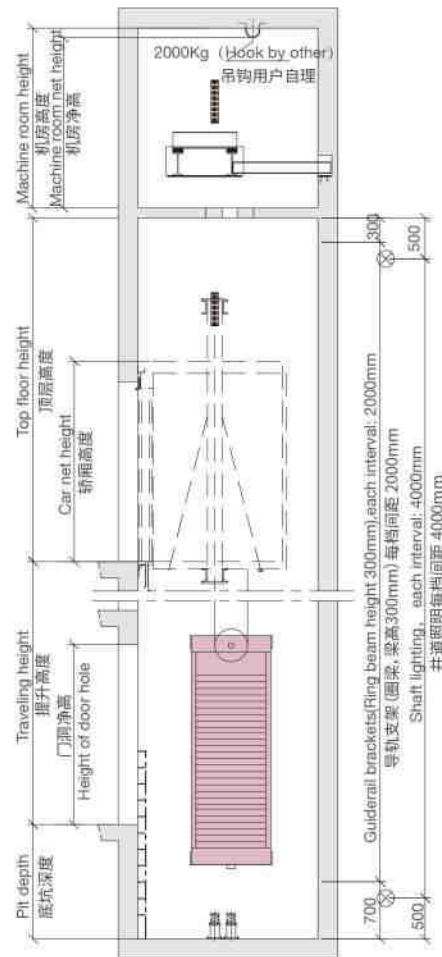

Machine room plane layout
机房平面布置图



Shaft plane layout
井道平面布置图

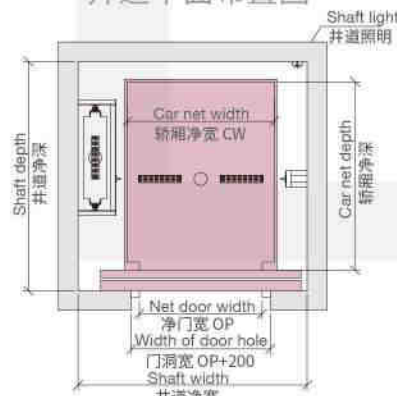

Shaft vertical section layout
井道立面布置图

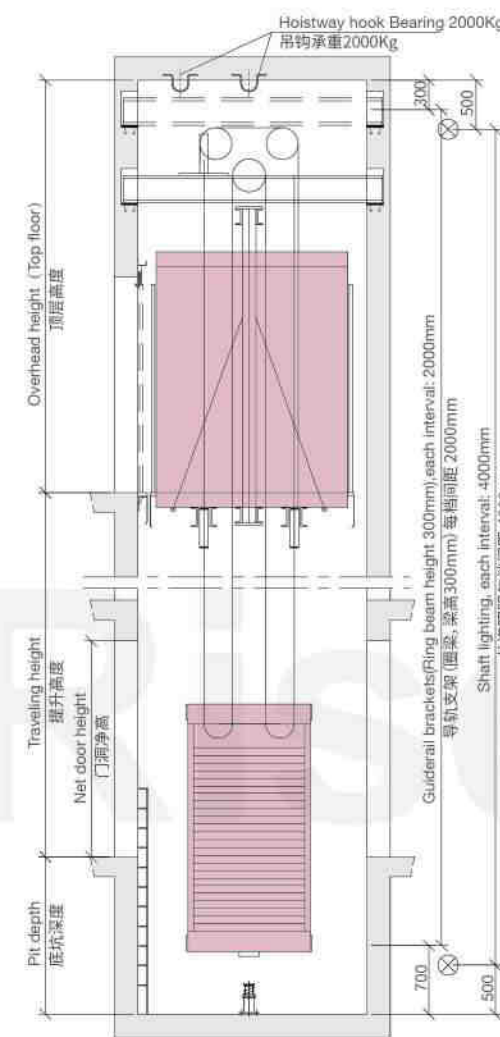

Top floor planform
顶层平面布置图

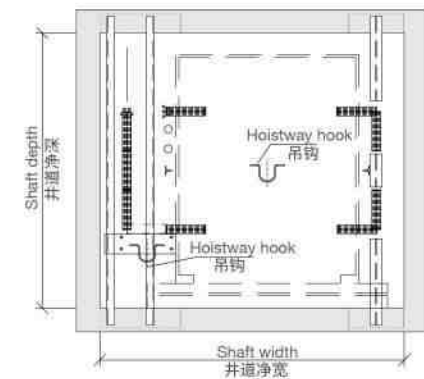

Shaft plane layout
井道平面布置图

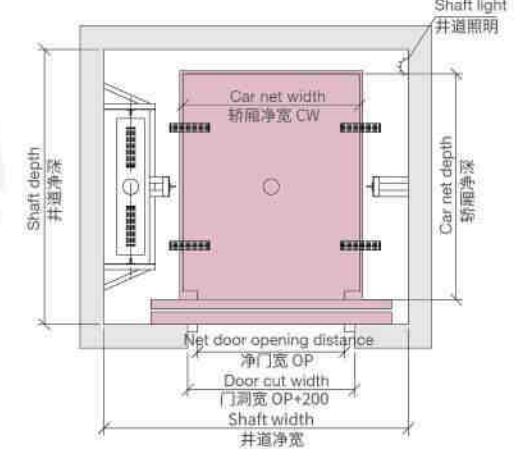

Freight elevator construction parameters 载货电梯土建参数

Load (kg) 载重量	Speed(m/s) 速度	Door open type 开门方式	Car size 轿厢尺寸 CW×CD	Door open size 开门尺寸 OP×OPH	Shaft size 井道尺寸 HW×HD	Machine room size 机房尺寸 MW×MD×HT	Pit depth 底坑深度PD	Overhead height 顶层高度OH
1000	0.5	Center opening 中分	1400×1600	1000×2100	2200×2100	2200×3600	1400	4200
	1.0	Double-folded side-opening 双折旁开		1200×2100				
1600	0.5	Center opening double-folded 中分双折	1500×2300	1300×2100	2400×2800	2400×4000	1400	4300
	1.0	Double-folded side-opening 双折旁开		1300×2100				
2000	0.5	Center opening double-folded 中分双折	1900×2200	1600×2200	2950×2700	2950×4000	1500	4500
		Double-folded side-opening 双折旁开		1600×2200	2800×2700	2800×4000		
3000	0.5	Center opening double-folded 中分双折	2200×2550	1800×2200	3300×3050	3300×4200	1600	4600
		Double-folded side-opening 双折旁开		1800×2200	3150×3050	3150×4200		
5000	0.25	Center opening double-folded 中分双折	2500×3500	2400×2200	4000×4000	4050×5000	1600	4600
	0.5	Center opening double-folded 中分双折		2400×2200	4000×4000	4050×5000		

The data is for design reference only. For the detailed parameters, please take the technical drawing as the criterion.
(本资料仅供设计选用参考,详细参数以技术图纸为准。)

Machine roomless freight elevator construction parameters 无机房载货电梯土建参数

Load (kg) 载重量	Speed(m/s) 速度	Door open type 开门方式	Car size 轿厢尺寸 CW×CD	Door open size 开门尺寸 OP×OPH	Shaft size 井道尺寸 HW×HD	Pit depth 底坑深度PD	Overhead height 顶层高度OH
1000	0.5	双折旁开 Double-folded side-opening	1400×1600	1200×2100	2200×2100	1400	4200
	1.0						
2000	0.5		1900×2200	1600×2100	3050×2700	1600	4500
3000	0.5		2000×2900	1800×2100	3400×3400	1600	4600
4000	0.5		2200×3350	2000×2100	3800×3850	1600	4950
5000	0.5		2200×4090	2200×2100	4000×4600	1600	4950

The data is for design reference only. For the detailed parameters, please take the technical drawing as the criterion.
(本资料仅供设计选用参考,详细参数以技术图纸为准。)



HOME ELEVATOR

家用电梯

Home elevator, it's not only an elevator in the house, but also a household appliance which upgrades people's home life.

LG professional home elevator adhere to the product concept of "Precision, Customization, Profession", applies more advanced intelligent and secure technology, chooses more superior materials and equipment, to be the upgraded choice of modern people who pursue good life quality.

家用电梯, 不仅仅是一台在家里使用的电梯, 更是一台家用电器, 极大提升了人们的家庭生活品质。

LG专业家用电梯, 秉承“精工、定制、专业”的产品理念, 运用更先进的智能和安全科技, 选用更精良的材质和配置, 倾力打造安全、健康、智能、舒适的家用电梯, 成为现代人追求极致生活品质的升级之选。

Shaft Frame

井道框架

Semicircle external glass structure
半圆型 外装玻璃结构

Circle internal and external glass structure
全圆 内外装玻璃结构

Square external glass structure
方型 内外装玻璃结构

Shaft glass color optional selection
井道玻璃颜色选配



Frosted glass
磨砂玻璃



Transparent glass
透明玻璃



Brown glass
褐色玻璃



Dark grey glass
深灰色玻璃



Traction-type Home Elevator

曳引式家用电梯

It doesn't need a dedicated machine room. Occupies a small area in shaft. Has low requirements for the top height and the pit depth. It is suitable for various villa structures. Runs stably, without unbalance loading.

无需专用机房, 井道占用面积小, 顶层高度和底坑深度要求低, 适用于各类别墅建筑结构, 运行稳定无偏载, 堪称家用电梯领域的经典之作。

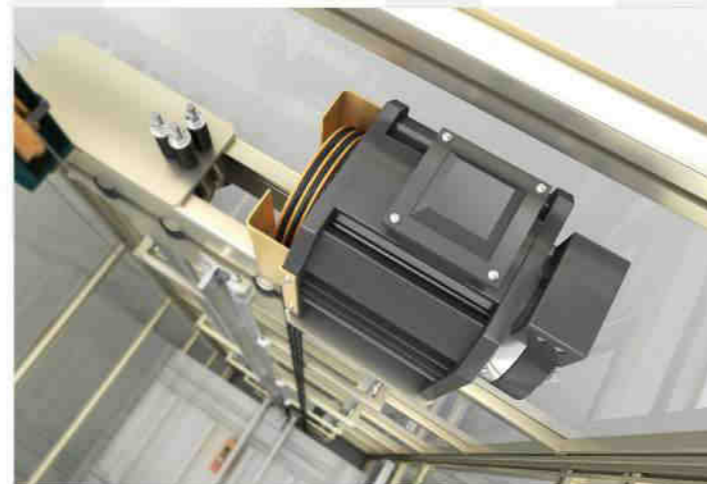

Steel Belt-type Home Elevator

钢带式家用电梯

It changes the traditional main motor technology, adopts the design integrating driving wheels and traction rods. The efficiency of its main motor is 20% higher than that of drive motors. The composite flat steel belt has features like high wear resistance and low vibration, which ensures stable and quiet running for long time.

突破传统主机技术, 采用驱动轮和曳引杆一体化设计, 主机效率比传动电机高20%, 复合扁平钢带, 高耐磨、低振幅、无感乘行, 舒适舒心。



Different Doors Of Home Elevator

家用电梯各类型门



Mirror stainless steel
镜面不锈钢



Short hairline stainless steel
(Anti-fingerprint)
短丝抗指纹不锈钢



Automatic glass door
自动玻璃门



Rose gold stainless steel
玫瑰金不锈钢



Rose gold mirror etching stainless steel
玫瑰金镜面蚀刻不锈钢



Titanium mirror etching stainless steel
钛金镜面蚀刻不锈钢



Glass door with gold frame by hand
手拉钛金边框玻璃门



Glass door by hand
手拉玻璃门

HOME ELEVATOR

家用电梯



LG-J01

Side wall: Hairline stainless steel
Rear wall: Hairline stainless steel
Ceiling: Hairline stainless steel + LED lights
Floor: PVC/Marble
Handrail: Hairline stainless steel
COP: LG-CZ002
HOP: LG-WH001

侧壁:发纹不锈钢
后壁:发纹不锈钢
吊顶:发纹不锈钢+LED灯
地板:PVC/大理石
扶手:发纹不锈钢
操纵箱:LG-CZ002
外呼:LG-WH001



LG-J02

Side wall: Hairline stainless steel + Mirror stainless steel
Rear wall: Hairline stainless steel
Ceiling: Hairline stainless steel + LED lights
Floor: PVC/Marble
Handrail: Hairline stainless steel
COP: LG-CZ002
HOP: LG-WH001

侧壁:发纹不锈钢+中间镜面不锈钢
后壁:发纹不锈钢
吊顶:发纹不锈钢+LED灯
地板:PVC/大理石
扶手:发纹不锈钢
操纵箱:LG-CZ002
外呼:LG-WH001



LG-J03

Side wall: Mirror stainless steel
Rear wall: Mirror stainless steel
Ceiling: Mirror stainless steel + LED lights
Floor: PVC/Marble
Handrail: Mirror stainless steel
COP: LG-CZ002
HOP: LG-WH001

侧壁:镜面不锈钢
后壁:镜面不锈钢
吊顶:镜面不锈钢+LED灯
地板:PVC/大理石
扶手:镜面不锈钢
操纵箱:LG-CZ002
外呼:LG-WH001



LG-J04

Side wall: Mirror etched stainless steel
Rear wall: Mirror etched stainless steel
Ceiling: Mirror stainless steel+LED lights
Floor: PVC/Marble
Handrail: Mirror stainless steel
COP: LG-CZ002
HOP: LG-WH001

侧壁:镜面蚀刻不锈钢
后壁:镜面蚀刻不锈钢
吊顶:镜面不锈钢+LED灯
地板:PVC/大理石
扶手:镜面不锈钢
操纵箱:LG-CZ002
外呼:LG-WH001



LG-J05

Side wall: Mirror stainless steel
Rear wall: Wooden grain + Hairline stainless steel
Ceiling: Mirror stainless steel + LED lights
Floor: PVC/Marble
Handrail: Mirror rosewood
COP: LG-CZ002
HOP: LG-WH001

侧壁:镜面不锈钢
后壁:木纹钢板+发纹不锈钢
吊顶:镜面不锈钢+LED灯
地板:PVC/大理石
扶手:镜面红木
操纵箱:LG-CZ002
外呼:LG-WH001



LG-J06

Side wall: Wooden grain + Titanium black mirror stainless steel
Rear wall: Wooden grain + Mirror stainless steel + Titanium black mirror stainless steel frame
Ceiling: Mirror stainless steel + LED lights
Floor: PVC/Marble
Handrail: Mirror stainless steel
COP: LG-CZ002
HOP: LG-WH001

侧壁:木纹钢板+钛黑不锈钢
后壁:木纹钢板+镜面不锈钢+钛黑不锈钢框架
吊顶:镜面不锈钢+LED灯
地板:PVC/大理石
扶手:镜面不锈钢
操纵箱:LG-CZ002
外呼:LG-WH001



LG-J07

Side wall: Titanium hairline stainless steel
Rear wall: Titanium mirror stainless steel + Titanium hairline stainless steel
Ceiling: Titanium mirror stainless steel + LED lights
Floor: PVC/Marble
Handrail: Titanium stainless steel
COP: LG-CZ002
HOP: LG-WH001

侧壁:钛金发纹不锈钢
后壁:钛金镜面不锈钢+钛金发纹不锈钢
吊顶:钛金镜面不锈钢+LED灯
地板:PVC/大理石
扶手:钛金不锈钢
操纵箱:LG-CZ002
外呼:LG-WH001



LG-J08

Side wall: Wooden grain
Rear wall: Wooden grain + Mirror stainless steel
Ceiling: Mirror stainless steel + LED lights
Floor: PVC/Marble
Handrail: Wooden grain + Titanium stainless steel
COP: LG-CZ002
HOP: LG-WH001

侧壁:木纹钢板
后壁:木纹钢板+镜面不锈钢
吊顶:镜面不锈钢+LED灯
地板:PVC/大理石
扶手:木纹+钛金不锈钢
操纵箱:LG-CZ002
外呼:LG-WH001



LG-J09

Side wall: Wooden grain
Rear wall: Mirror stainless steel + Wooden grain
Ceiling: Mirror stainless steel+LED lights
Floor: PVC/Marble
Handrail: Titanium stainless steel
COP: LG-CZ002
HOP: LG-WH001

侧壁:木纹钢板
后壁:镜面不锈钢+木纹钢板
吊顶:镜面不锈钢+LED灯
地板:PVC/大理石
扶手:钛金不锈钢
操纵箱:LG-CZ002
外呼:LG-WH001

HOME ELEVATOR

家用电梯



LG-J10

Ceiling: Mirror stainless steel, acrylic transparent panel, LED lights
Car wall: hairline stainless steel, champagne gold mirror stainless steel etching, champagne gold mirror stainless steel, black acrylic strip
Floor: PVC (marble optional)

吊顶: 镜面不锈钢、亚克力透光板、LED灯
轿壁: 发纹不锈钢、香槟金镜面不锈钢蚀刻、香槟金镜面不锈钢、黑色亚克力嵌条
地板: PVC (可选大理石)



LG-J11

Ceiling: Black titanium mirror stainless steel
Car wall: Art glass + hairline stainless steel + black titanium mirror
Floor: PVC (marble optional)

吊顶: 黑钛镜面不锈钢
轿壁: 艺术玻璃+发纹不锈钢+黑钛镜面
地板: PVC (可选大理石)



LG-J12

Ceiling: High end customized platinum plate, LED light
Car wall: Mirror stainless steel, wood veneer
Floor: PVC (marble optional)

吊顶: 高端定制铂金板、LED灯
轿壁: 镜面不锈钢、木饰面
地板: PVC (可选大理石)



LG-J13

Ceiling: four sides of black titanium stainless steel decorative strip, steel spray around hidden lights with light, small spotlights
Car wall: Champagne hairline stainless steel, wood finish, black titanium trim strip, hidden lighting
Floor: PVC (marble optional)

吊顶: 四边黑钛不锈钢装饰条、钢板、喷塑四周暗藏灯带光、小射灯
轿壁: 香槟金发纹不锈钢、木饰面、黑钛装饰条、暗藏灯光
地板: PVC (可选大理石)



LG-J14

Ceiling: Wood veneer, rose hairline stainless steel, hidden light belt around, LED lights (stainless steel can be sprayed with steel)
Car wall: Rose gold etching
Floor: PVC (marble optional)

吊顶: 木饰面、玫瑰金发纹不锈钢、四周暗藏灯带、LED灯 (可钢板喷塑包不锈钢)
轿壁: 玫瑰金蚀刻
地板: PVC (可选大理石)



LG-J15

Ceiling: rose gold mirror stainless steel, linear light, LED light
Car wall: Rose hairline stainless steel, rose gold mirror stainless steel etching
Floor: PVC (marble optional)

吊顶: 玫瑰金镜面不锈钢、线型灯、LED灯
轿壁: 玫瑰金发纹不锈钢、玫瑰金镜面不锈钢蚀刻
地板: PVC (可选大理石)



LG-J16

Ceiling: Black titanium mirror stainless steel modeling + spotlights + soft light on both sides of the acrylic lighting
Back wall: Black titanium hairline stainless steel (anti-fingerprint) + middle marble finish
Side wall: Black titanium hairline stainless steel (anti-fingerprint) + black titanium mirror stainless steel
Floor: Fish belly white rock slab

吊顶: 黑钛镜面不锈钢造型+射灯+两侧亚克力柔光照明
后壁: 黑钛发纹不锈钢 (抗指纹)+中间大理石饰面
侧壁: 黑钛发纹不锈钢 (抗指纹)+黑钛镜面不锈钢
地板: 鱼肚白岩板



LG-J17

Ceiling: Black titanium stainless steel, black titanium mirror stainless steel, light belt, LED light
Car wall: Black titanium hairline, black titanium mirror stainless steel
Floor: PVC (marble optional)

吊顶: 黑钛不锈钢、黑钛镜面不锈钢、灯带、LED灯
轿壁: 黑钛发纹、黑钛镜面不锈钢
地板: PVC (可选大理石)



LG-J18

Ceiling: Black titanium hairline stainless steel, LED lights, glass
Rear wall: Glass
Side walls: Black titanium hairline stainless steel, glass
Front wall: Black titanium hairline stainless steel, glass
Handrail: Black titanium stainless steel
Floor: PVC (marble optional)

吊顶: 黑钛发纹不锈钢、LED灯、玻璃
后壁: 玻璃
侧壁: 黑钛发纹不锈钢、玻璃
前壁: 黑钛发纹不锈钢、玻璃
扶手: 黑钛不锈钢
地板: PVC (可选大理石)



LG-J19

Ceiling: Starry sky ceiling
Rear wall: Glass
Side walls: Black titanium hairline stainless steel, glass
Front wall: Black titanium hairline stainless steel, glass
Handrail: Black titanium stainless steel
Floor: PVC (marble optional)

吊顶: 星空顶
后壁: 玻璃
侧壁: 黑钛发纹不锈钢、玻璃
前壁: 黑钛发纹不锈钢、玻璃
扶手: 黑钛不锈钢
地板: PVC (可选大理石)

CONSTRUCTION LAYOUT DRAWING

Home Elevator

家用电梯土建参数

Shaft vertical section layout
(C.W.T on two side)

井道立面布置图
(对重侧置)

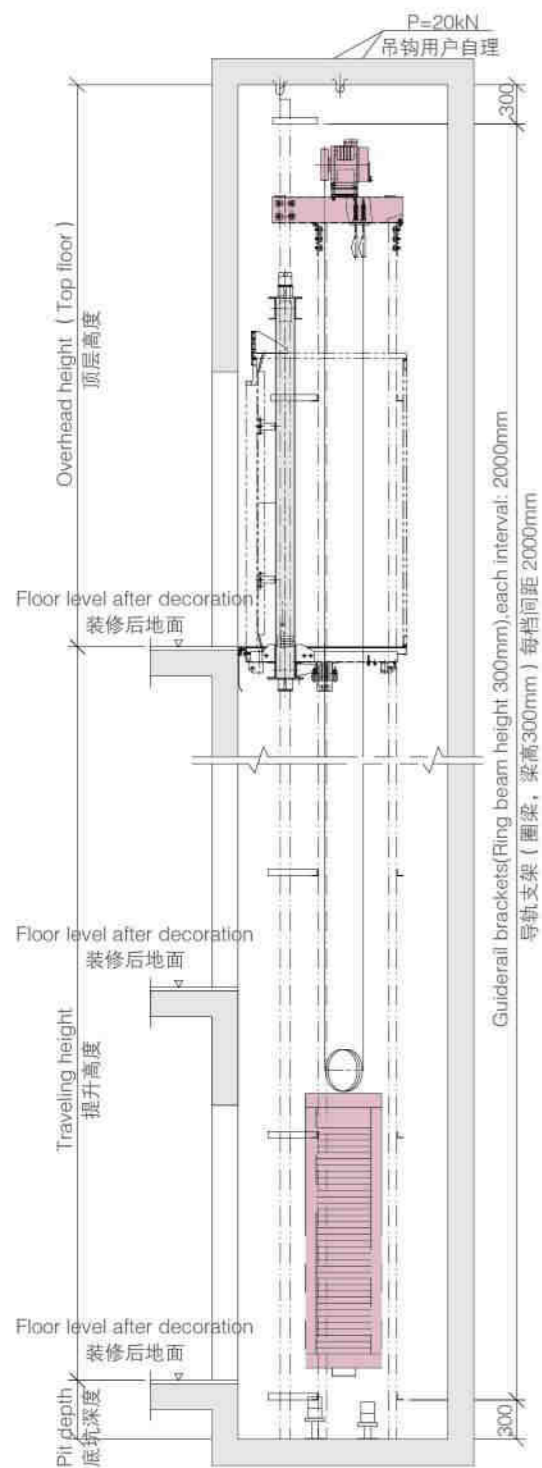

Shaft vertical section layout
(C.W.T on rear side)

井道立面布置图
(对重后置)

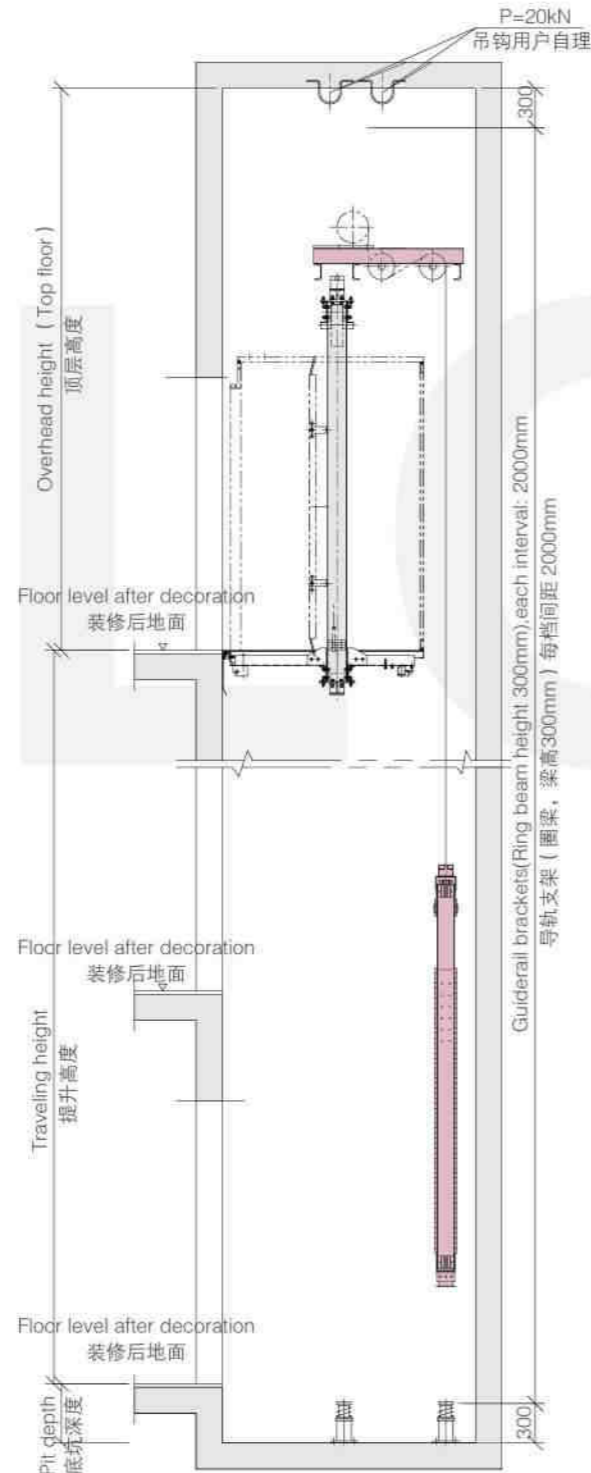

Shaft plane layout
(C.W.T on two side)

井道平面布置图
(对重侧置)

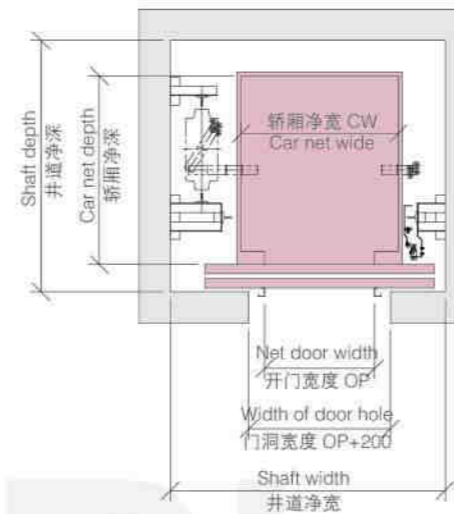

Shaft plane layout
(C.W.T on rear side)

井道平面布置图
(对重后置)

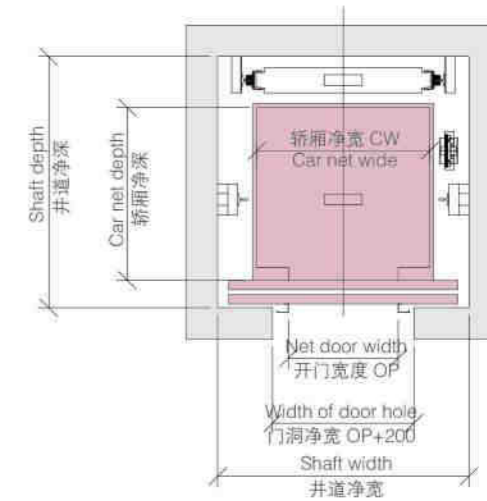

Home elevator construction parameters
家用电梯土建参数

Load 载重 (kg)	Speed 速度 (m/s)	Door opening size 开门尺寸 (mm)	Car size (mm) 轿厢尺寸 (宽×深) (Width×Depth)	Shaft Size (mm) 井道尺寸 (宽×深) (Width×Depth)	Over head height 顶层高度 (mm)	Pit depth 底坑深度 (mm)
250	0.4	600x2000	950x1000	1600x1350	3600	650
320	0.4	650x2000	1000x1050	1650x1400	3600	650
400	0.4	700x2000	1050x1100	1700x1450	3600	650

The data is for design reference only. For the detailed parameters, please take the technical drawing as the criterion.
(本资料仅供设计选用参考,详细参数以技术图纸为准。)

DOOR PANEL FINISHES

门板花纹

Etched stainless steel 蚀刻不锈钢

Etched stainless steel 蚀刻不锈钢



LG-T01
Hairline Stainless Steel
发纹不锈钢



LG-T02
Mirror Stainless Steel
镜面不锈钢



LG-T03
Painted Steel
喷涂钢板



LG-T04
Etched stainless steel
蚀刻不锈钢



LG-T13
Etched stainless steel
蚀刻不锈钢



LG-T14
Etched stainless steel
蚀刻不锈钢



LG-T15
Etched stainless steel
蚀刻不锈钢



LG-T16
Etched stainless steel
蚀刻不锈钢



LG-T05
Etched stainless steel
蚀刻不锈钢



LG-T06
Etched stainless steel
蚀刻不锈钢



LG-T07
Etched stainless steel
蚀刻不锈钢



LG-T08
Etched stainless steel
蚀刻不锈钢



LG-T17
Etched stainless steel
蚀刻不锈钢



LG-T18
Etched stainless steel
蚀刻不锈钢



LG-T19
Etched stainless steel
蚀刻不锈钢



LG-T20
Etched stainless steel
蚀刻不锈钢



LG-T09
Etched stainless steel
蚀刻不锈钢



LG-T10
Etched stainless steel
蚀刻不锈钢



LG-T11
Etched stainless steel
蚀刻不锈钢



LG-T12
Etched stainless steel
蚀刻不锈钢



LG-T21
Etched stainless steel
蚀刻不锈钢



LG-T22
Etched stainless steel
蚀刻不锈钢



LG-T23
Etched stainless steel
蚀刻不锈钢



LG-T24
Etched stainless steel
蚀刻不锈钢

Door Panels
门板

DOOR PANEL FINISHES

门板花纹

Gold mirror etched stainless steel 金色镜面蚀刻不锈钢



LG-T25

Gold mirror etched stainless steel
金色镜面蚀刻不锈钢



LG-T26

Gold mirror etched stainless steel
金色镜面蚀刻不锈钢



LG-T27

Gold mirror etched stainless steel
金色镜面蚀刻不锈钢



LG-28

Gold mirror etched stainless steel
金色镜面蚀刻不锈钢



LG-T29

Gold mirror etched stainless steel
金色镜面蚀刻不锈钢



LG-T30

Gold mirror etched stainless steel
金色镜面蚀刻不锈钢



LG-T31

Gold mirror etched stainless steel
金色镜面蚀刻不锈钢



LG-T32

Gold mirror etched stainless steel
金色镜面蚀刻不锈钢



LG-T33

Gold mirror etched stainless steel
金色镜面蚀刻不锈钢



LG-T34

Gold mirror etched stainless steel
金色镜面蚀刻不锈钢



LG-T35

Gold mirror etched stainless steel
金色镜面蚀刻不锈钢



LG-T36

Gold mirror etched stainless steel
金色镜面蚀刻不锈钢

Rose gold mirror etched stainless steel / Glass door

玫瑰金镜面蚀刻不锈钢 / 玻璃门



LG-T37

Rose gold mirror etched stainless steel
玫瑰金镜面蚀刻不锈钢



LG-T38

Rose gold mirror etched stainless steel
玫瑰金镜面蚀刻不锈钢



LG-T39

Rose gold mirror etched stainless steel
玫瑰金镜面蚀刻不锈钢



LG-T40

Rose gold mirror etched stainless steel
玫瑰金镜面蚀刻不锈钢



LG-T41

Rose gold mirror etched stainless steel
玫瑰金镜面蚀刻不锈钢



LG-T42

Rose gold mirror etched stainless steel
玫瑰金镜面蚀刻不锈钢



LG-T43

Rose gold mirror etched stainless steel
玫瑰金镜面蚀刻不锈钢



LG-T44

Rose gold mirror etched stainless steel
玫瑰金镜面蚀刻不锈钢



LG-T45

Safety laminated glass + Hairline
stainless steel frame
安全夹胶玻璃+发纹不锈钢边框



LG-T46

Safety laminated glass + Hairline
stainless steel frame
安全夹胶玻璃+发纹不锈钢边框



LG-T47

Safety laminated glass + Hairline
stainless steel frame (Manual door)
安全夹胶玻璃+发纹不锈钢边框
(手动门)



LG-T48

Safety laminated glass + Hairline
stainless steel frame
安全夹胶玻璃+发纹不锈钢边框

CAR OPERATION PANEL (C.O.P)

轿厢操纵箱(操作面板)



LG-CZ001

一体式(Integrated Type)
蓝色液晶显示
(Blue LCD display)

LG-CZ002

一体式(Integrated Type)
黑底白字点阵显示
(White Dot Matrix Display)

LG-CZ003

一体式(Integrated Type)
图片/视频显示
(Picture/Video Display)

LG-CZ004

分体式(Independent Type)
黑底白字点阵显示
(White Dot Matrix Display)

MORE DISPLAY TYPES

更多的显示类型

Dot Matrix Display 点阵显示器



Red on black,
single display
黑底红字, 单显



White on black,
single display
黑底白字, 单显



Yellow on black,
single display
黑底黄字, 单显

Segment Display 段码显示器



White on blue
蓝底白字



White on black
黑底白字



Yellow on black
黑底黄字

Picture & Video Display (Transverse type)

液晶显示器(横显)



8.1inch-19 inch

Picture & Video Display (Vertical type)

液晶显示器(竖显)



8.1inch-19 inch

Button Background Light

按钮背景光



White
白色



Yellow
黄色

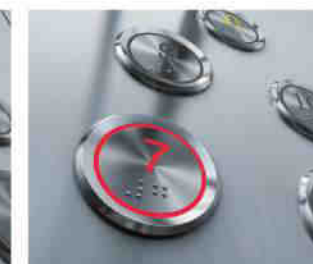

Red
红色



Green
绿色

C.O.P & H.O.P
操纵箱 & 外呼

MORE TYPES C.O.P

更多类型的操纵箱

C.O.P For Home Elevator

家用电梯操纵箱



LG-JW01



LG-JW02

C.O.P For Disabled Persons

残疾人操纵箱



LG-CJ01

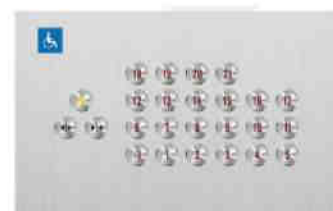

LG-CJ02

Touch Screen C.O.P

触控式操纵箱



LG-CP01(10.4 in)



LG-CP02(12.1 in)



LG-CP03(28.6 in)



LG-CP04(38 in)

HALL OPERATION PANEL (H.O.P)

厅门呼叫面板(外呼)

Hall Operation Panels (H.O.P) Without bottom box

无底盒外呼



LG-WH001



LG-WH002



LG-WH003



LG-WH004



LG-WH005



LG-WH006



LG-WH007



LG-WH008



LG-WH009



LG-WH010

Duplex H.O.P

并联外呼



LG-WH001D



LG-WH002D



LG-WH003D



LG-WH004D



LG-WH005D



LG-WH006D

MORE FASHIONABLE C.O.P & H.O.P OPTIONS

更多时尚操纵箱和外呼



LG-CZ005

LG-WH011

LG-CZ006

LG-WH012

H.O.P For Home Elevator

家用电梯外呼



LG-JW03

LG-JW04

LG-JW05

LG-JW06

Transom Display Panels

横梁显示



LG-MM01

LG-MM02

LG-MM03

LG-MM04

LG-MM05

LG-MM06

ARRIVAL LIGHTS

到站灯



LG-DZ01

LG-DZ02

LG-DZ03

LG-DZ04

LG-DZ05

LG-DZ06

NEW WIDE JAMB MATERIAL

新型大门套材料



LG-MT01

LG-MT02

LG-MT03

LG-MT04

LG-MT05

LG-MT06

LG-MT07

LG-MT08

HANDRAILS

扶手



LG-H01
Single tube mirror
单管镜面



LG-H02
Single tube titanium
单管钛金



LG-H03
Double tube mirror
双管镜面



LG-H04
Double tube titanium
双管钛金



LG-H05
Three-tube handrail
三管扶手



LG-H06
Three-tube titanium
三管钛金



LG-H07
Titanium rosewood
钛金红木



LG-H08
Titanium rosewood
钛金红木



LG-H09
Flat steel hairline
扁钢发纹



LG-H10
Flat steel rose gold
扁钢玫瑰金



LG-H11
Solid wood, stainless steel on both sides
实木, 两边不锈钢



LG-H12
Titanium stainless steel
钛金不锈钢

Handrails For Panoramic Elevator

观光电梯扶手

We design different kinds of handrails with different materials, like stainless steel round pipe, ellipse pipe, titanium gold pipe, square pipe, wooden pipe, hairline pipe, you can select one which you prefer.

本公司根据不同轿厢装饰之特点, 设计了不锈钢圆管、椭圆管、方管、钛金管、木质、不锈钢发纹板、有机柱等不同材质, 不同式样的扶手十余款, 造型优美、尺寸齐全, 用户在购买轿厢装饰时可根据个人喜好自由选配。

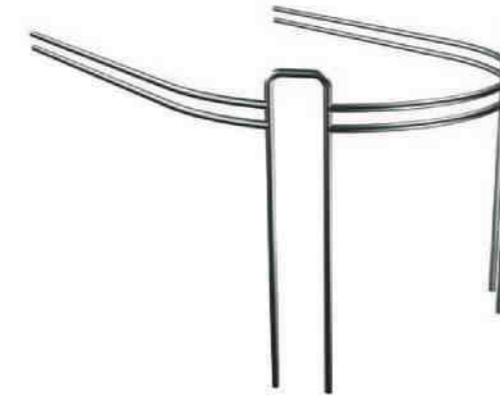

LG-HG01
Stainless steel tube model handrail
不锈钢圆管造型扶手



LG-HG02
Stainless steel tube model handrail
不锈钢圆管造型扶手



LG-HG03
Stainless steel tube model handrail
不锈钢圆管造型扶手



LG-HG04
Pair stainless steel tube for handrail
不锈钢双联圆管扶手



LG-HG05
Stainless steel tube model handrail
不锈钢圆管造型扶手



LG-HG06
Triple stainless steel tube for handrail
不锈钢三联圆管扶手

Handrails
扶手

CEILING

吊顶



FLOORS (PVC/MARBLE)

地板 (PVC/大理石)



Ceilings / Floors
吊顶/地板



ESCALATOR

自动扶梯

LG Rise

Our escalators will meet the requirements of different customers by excellent performance as well as practical and flexible design. The Variable Voltage and Variable Frequency (VVVF) technology, and refined manufacture process, make the escalators more perfect, secure, energy-saving and easier for maintenance.

Escalators are widely used in the places with large passenger flow like shopping malls, supermarkets, subways and airports, etc. Our esalators have features including beautiful appearance, deliate&stable structure, durable steps, modern senses.

我们的自动扶梯以性能优良、实用、灵活的设计满足不同客户的需求。微机变频技术 (VVVF) 和人机工程学研究成果以及先进制造技术的优先运用, 使自动扶梯更趋完美、安全、舒适、节能、维修方便。

自动扶梯广泛应用于商场、超市、地铁、机场等客流量大的场所, 我们的自动扶梯具备结构精巧、梯路优良、带路精致、外观造型精美、充满现代气息等特点。

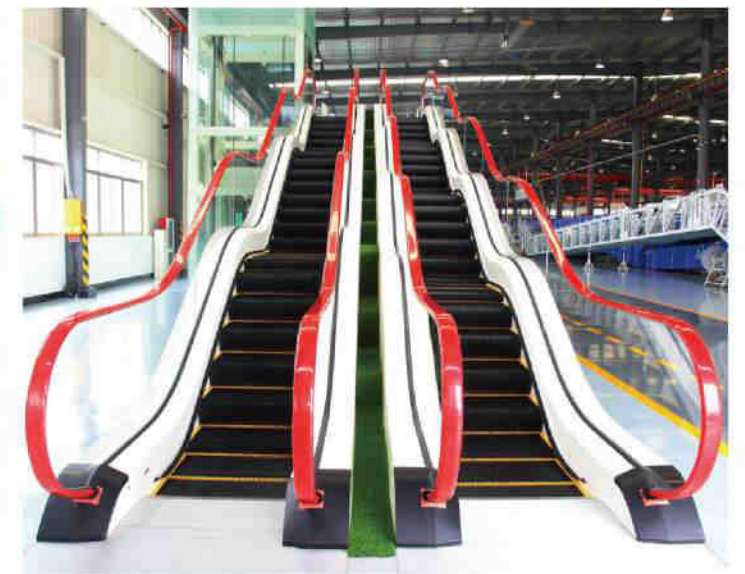

EIGHT SAFETY DESIGNS

八大安全设计



1 Handrail entry protection 扶手入口安全保护

Safety protective device is installed at handrail entry. The escalator will stop running when unknown objects are clamped at handrail entry.

扶手带入口装有安全保护装置, 当外物被夹在扶手带入口时, 自动扶梯将自动停止运行。



2 Step sagging protection 梯级下陷保护

In order to guarantee the passengers' and equipment's safety, the escalator will stop running when the step is sagging or broken.

当梯级出行塌陷等损坏时, 为了保证乘客人身安全和设备设施安全, 自动扶梯将会立即停止。



3 Drive chain protection 驱动连接保护

The escalator will stop running when the drive chains are over pulled or broken.

当驱动链被过度拉伸或断裂时, 自动扶梯将自动停止运行。



4 Anti-reversal protection 非操作逆转保护

Speed and running direction sensors are installed at machine side. The machine will safety brake when the escalator makes non-operating reverse.

主机侧装有速度和方向传感器, 当扶梯发生逆转时, 主机安全制动。

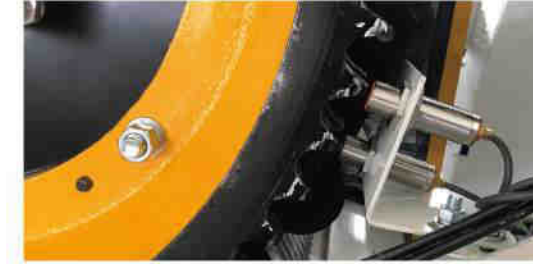

5 Step chain break protection 梯级链断裂保护

The escalator will stop running when the step chain is broken, over pulled or over shortened.

当梯级链断裂或过分伸长、缩短后, 自动扶梯将会立即停止运行。



6 Comb plate protection 梳齿安全保护

When unknown objects are placed in between moving steps and static comb plate, the safety switches installed to monitor two sides of comb plate will be activated, thus the escalator will stop running.

若异物夹在运动的梯级和静止的梳齿板之间, 触发监控梳齿板两侧的安全开关, 自动扶梯便会自动停止。



7 Emergency stop button 急停按钮

The escalator will stop running when the button is pressed.

当按此按钮时, 自动扶梯停止运行。



8 Landing plate opening protection device 楼层板打开保护装置

The landing plate safety switch will be activated when landing plate is opened, which will cut off the safety circuit and the escalator stops running.

当楼层板打开, 楼层板安全开关工作, 切断安全回路, 自动扶梯停止运行。



ESCALATOR FUNCTION

扶梯功能配置

标准功能配置 Standard Function	功能说明 Function Introduction
Drive chain safety device 驱动链安全装置	If the drive chain is broken or unnecessarily long, it will touch and activate the safety switch, which will cut off the safety circuit and make the escalator stop running. 驱动链断链或过长,即碰安全开关,安全开关动作,切断安全回路;自动扶梯停止运行。
Phase protection device 错、断相保护装置	The device will be activated when power phase dislocation or lack detected, which will make the escalator stop running or unable to start. 在检测到电源错相或断相时动作,自动扶梯停止运行或不能启动。
Step chain broken protection device 梯级链断链保护装置	Step chain broken switches are installed at the two sides of lower machine room. When the step chain is abraded or unnecessarily shortened with unknown reason, the safety switches will be activated to cut off the safety circuit and the escalator stop running. 在自动扶梯下段机房内两边装有梯级链断链开关,当梯级链条由于磨损或其它原因过长缩短时,安全开关动作,切断安全回路,自动扶梯停止运行。
Handrail entry protection device 扶手入口保护装置	If any unknown objects get clamped at handrail entry, the switch will be activated to cut off the safety circuit and the escalator stop running. 在扶手带出入口处若有异物夹住,安全开关就断开,切断安全回路,自动扶梯停止运行。
Emergency stop button 紧急停止按钮	Emergency stop buttons are installed at upper and lower ends. Press the emergency stop buttons when there is any emergent situation to cut off the safety circuit to stop the escalator from running. 在自动扶梯的上下端设有紧急停止按钮,当发生紧急情况时,按下紧急停止按钮,切断安全回路,自动扶梯停止运行。
Non-operating reversal protection device 非操作逆转保护装置	When the escalator is changing its set running direction, the control system will make the motor off power, and the escalator will stop running. 当自动扶梯发生改变既定运行方向时,控制系统使电机失电,扶梯停止运行。
Comb plate safety device 梳齿板安全装置	When unknown objects are into comb plate, the comb plate will make some movements to front. When moves to a certain distance, the inclined block under comb plate will strike the safety switch and activate it, then the safety circuit will be cut off and the escalator stop running. 当异物嵌入梳齿板后,梳齿板向前移动,当移动到一定距离时,梳齿下方的斜块撞击安全开关,安全开关动作,切断安全回路,自动扶梯停止运行。
Landing plate opening protection device 楼层板打开保护装置	The landing plate safety switch will be activated when landing plate is opened, which will cut off the safety circuit and the escalator stop running. 当楼层板打开,楼层板安全开关工作;切断安全回路,自动扶梯停止运行。
Step missing protection device 梯级丢失保护装置	When step is detected to be missing, the control system will stop the escalator from running. 当监测到梯级缺失时,控制系统使扶梯停止运行。
Handrail speed detection protection 扶手带测速保护	When the handrail speed is not in accordance with step running speed, the system will stop the escalator from running. 当扶手带速度与梯级运行速度不同时,系统将自动检测,并使扶梯停止运行。
Step sagging protection device 梯级下陷保护装置	When step or roller is broken, it will sag and activate the safety switch, which will cut off the safety circuit and stop the escalator from running. 当梯级断裂或滚轮破裂时梯级下陷开关启动,切断安全回路,自动扶梯停止运行。
Motor overload protection 电机过载保护	When the motor current is detected to over the set value, safety switch will be activated, then to stop the escalator from running. 在检测到电机电流超过设定值时动作,自动扶梯停止运行。
Circuit grounding device 电路接地装置	Grounding device is set in control system circuit, which will effectively protect the electrical components from damages and improve the escalator running reliability. 在控制系统电路中设置了接地装置,有效地保护电器原件不受损坏,增加了扶梯运行可靠性。
Step gap illumination 绿色梯级间隙照明	Install green lighting below the steps at upper and lower ends, which improve the brightness at entrance and exit, leading passengers to safely taking the escalators. 在上下端出入口处梯级下设置绿色照明,提高了出入口的亮度,引导乘梯人员安全乘梯。
Overspeed & underspeed protection 超速欠速保护	When escalator is running at set overspeed or underspeed, the control system will cut off motor power so that the escalator will stop running. 当扶梯超速欠速达到设定值运转时,控制系统使电机失电,扶梯停止运行。
Upper and lower inspection switches and sockets 上下检修开关及插座	Inspection switches and sockets are installed at upper and lower machine room, which is convenient for the maintenance worker to do their job. 在上下机房内设置检修开关及插座,方便了维护人员进行检修和维护作业。
Yellow demarcation lines 安全黄色警戒线	The steps are with yellow demarcation lines at front and sides, leading passengers to safely taking the escalator and improve the safety. 在梯级的上平面前端和两侧设置安全黄色警戒线,引导乘梯人员安全乘梯,增加了乘梯人员的安全性。
Automatic lubrication device 自动加油装置	Automatic lubricating system with oil level detection device will stop the escalator to avoid over abrasion. 自动扶梯的自动加油润滑系统,带油位检测功能,当油量过少时,自动扶梯停梯,防止过度磨损。
Brake release detecting 抱闸打开检测	When the escalator is setting in motion and the brake didn't release, the control system will cut off motor power to stop the escalator from running to protect the machine. 当自动扶梯启动,主机制动抱闸没有打开,为了保护主机,控制系统使电机失电,扶梯停止运行。
Step anti-static brush 梯级防静电刷	This device will induct the step surface static electricity into ground to avoid the electric shock when passengers touch the steps. 该装置将梯级表面的静电导入大地,避免人体接触时的触电感。
Skirt panel anti-clamp device 裙板防夹装置	When passengers stand at the edges of the step, they will touch the brush. It will remind them to stand at the middle of the step to avoid their cloths getting clamped into the gaps between steps and skirt panel. 当人站在梯级边缘时就会碰到毛刷,提醒人站到梯级的中间,防止衣物夹入梯级与裙板之间的缝隙。
Fault code display 故障代码显示	When there is any fault, the fault display will show the fault codes to ensure that parts with fault can be precisely noticed, which can greatly improve maintenance efficiency. 当有故障发生时,故障代码就会显示在故障屏幕上,准确的判断故障部位,大大地提高了维修效率。

标准功能配置 Standard Function	功能说明 Function Introduction
Handrail anti-static device 扶手带防静电装置	This device will induct the handrail surface static electricity into ground to avoid the electric shock when passengers touch the handrail. 该装置将扶手带表面的静电导入大地,避免人手接触时的触电感。
Start-up alarm 启动警铃	When the escalator is setting in motion, the start-up alarm will ring to warn the passengers to keep eye on their safety. 在扶梯启动时,启动警铃响起,警示乘梯人员注意安全。
Working brake 工作制动器	It's a main device to brake the escalator. When the escalator is setting in motion, the motor brake will release and escalator runs at normal conditions. When escalator stops, the working brake will be power off and activated and thus escalator stops running. 该装置是制停扶梯的主要装置,当自动扶梯启动,主机抱闸打开,正常运行;当扶梯停止,工作制动器失电工作,扶梯停止运行。
Machine room protection plate 机房防护板	Protection plate is used to separate moving parts area and static parts area at upper and lower machine rooms to ensure maintenance workers' safety. 在上下机房内,运动件区域和非运动件区域采用防护板隔开,保障检修人员的安全。
Machine flywheel guard opening monitoring switch 主机飞轮打开监测开关	When use handwheel device, control system will make the motor power off, enable to start up in order to keep maintenance workers' safety. 当采用手动盘车装置盘车时,为了保护检修人员安全,控制系统使电机失电,不能启动。
Hand wheel protection 手动盘车保护	Protection Cover is installed on machine hand wheel flywheel to keep workers from damages. 在主机手动盘车飞轮上加装保护罩,避免人员受伤害。
Main power switch 主电源开关	Main power switch is installed above the controller, which is convenient for the maintenance workers to cut off the power once enter into the machine room. 在控制柜的上方设置主电源开关,当检修人员在进入机房前就可以方便地切断电源。
Portable lighting 手提行灯照明	Portable lighting is equipment, which can be convenient for the maintenance workers to get access to lights. 在扶梯中配置手提行灯照明,方便检修人员照明使用。
Safety alarm signs 安全警示标志	Safety alarm signs are installed at upper and lower ends according to relevant standards to warn passengers to keep an eye on safety. 在扶梯的上下端按国标要求设置安全警示标志,提醒乘梯人员安全乘梯。

可选功能配置 Optional Function	功能说明 Function Introduction
VVVF low speed 变频低速	Adopts economic dual speed running mode according to the passenger flows where the escalators are installed. When there is no passenger, the escalator will automatically change to run at a low speed; once there is a passenger coming up, it will change to normal running speed, which is more efficient and energy-saving. 根据扶梯使用场合的流量,采用经济双速运行模式,当无人乘梯时,扶梯自动转换为低速运行;当有人乘梯时,扶梯自动转换为正常速度运行;以达到高效、节能的效果。
Auxiliary brake 附加制动器	The auxiliary brake will be put into use when the working brake is not working or drive chain broken, which effectively slowly stop the downward running escalator and finally keep static to ensure passengers' safety. 当工作制动器失效或驱动链断裂的情况下,附加制动器工作,能有效地使向下运行的扶梯减速停止,并保持静止状态,保障乘梯人员的安全。
Handrail broken protection device 扶手带断带保护装置	When the handrail is broken during escalator running, the handrail broken protection switch will be activated and cut off the safety circuit, and then the escalator will be stopped. 当自动扶梯在运行过程中扶手带断带,此时扶手带断带开关动作,切断安全回路,自动扶梯停止运行。
Skirt panel protection device 裙板挤压保护装置	When unknown objects are into the gaps between steps and skirt panel, the skirt panel will be out of shape. When deformed to certain position, it will strike the safety switch and activate it, then the safety circuit will be cut off and the escalator stop running. 当异物进入梯级与裙板之间的缝隙时,裙板发生变形,达到一定位置后,撞击安全开关,安全开关动作,切断安全回路,自动扶梯停止运行。
VVVF auto-start 变频自启动	Adopts smart running modes according to the passenger flows where the escalators are installed. When there is no passenger, the escalator will automatically change to run at a low speed and then stops; once there is a passenger coming up, it will automatically start up, and quickly change to normal speed running, which is smarter, more efficient and energy-saving. 根据扶梯使用场合的流量,采用智能运行模式,当无人乘梯时,扶梯自动转换为低速运行,然后自动停止;当有人乘梯时,扶梯自动启动,并快速转换为正常速度运行;以达到智能、高效、节能的效果。
Comb lighting 梳齿照明	The comb lighting is installed on the skirt panel beside the comb plate, offering lighting to stop and comb plate, which help passengers safely take the escalator. 照明安装在靠近梳齿板旁的裙板上,为梯级和梳齿提供照明,使乘客安全乘梯。
Handrail lighting 扶手照明	Lighting is installed at upper part of handrail balustrade, which delivers more enjoyments and safety. 在扶手栏杆上部设置提供照明的照明装置,增添了乘坐的乐趣和安全性。
Skirt panel lighting 裙板照明	Lighting is installed at skirt panel, which delivers more enjoyments and safety. 在裙板处设置提供照明的照明装置,增添了乘坐的乐趣和安全性。
Oil/water separator 油水分离器	The oil and water will be separated via the oil/water separator. The water will be vented and oil regularly cleaned, which is environmentally friendly. 将扶梯中的油水经过油水分离器进行分离,雨水通过大器排出,油污进行定期清洗,起到环保作用。
Water level safety switch 水位安全开关	When the water level reaches alarm line, the water level safety switch will be activated and cut off the safety circuit, and then the escalator will stop running. 当自动扶梯进水达到警戒水位,水位安全开关工作,切断安全回路,自动扶梯停止运行。
Heating device 加热装置	Heating devices installed inside the escalator is mainly used to heat machine, control system, step route, comb plate and handrail ect. to avoid components frozen situations, which is suitable for public escalators at northern cold areas. 在自动扶梯内设置加热装置,主要作用是为主机、控制系统、梯路、梳齿板、扶手带等加热,解除冰冻。适用于北方寒冷地区的室外扶梯。

CONSTRUCTION LAYOUT DRAWING

E100 Commercial Escalator

E100商用自动扶梯土建参数

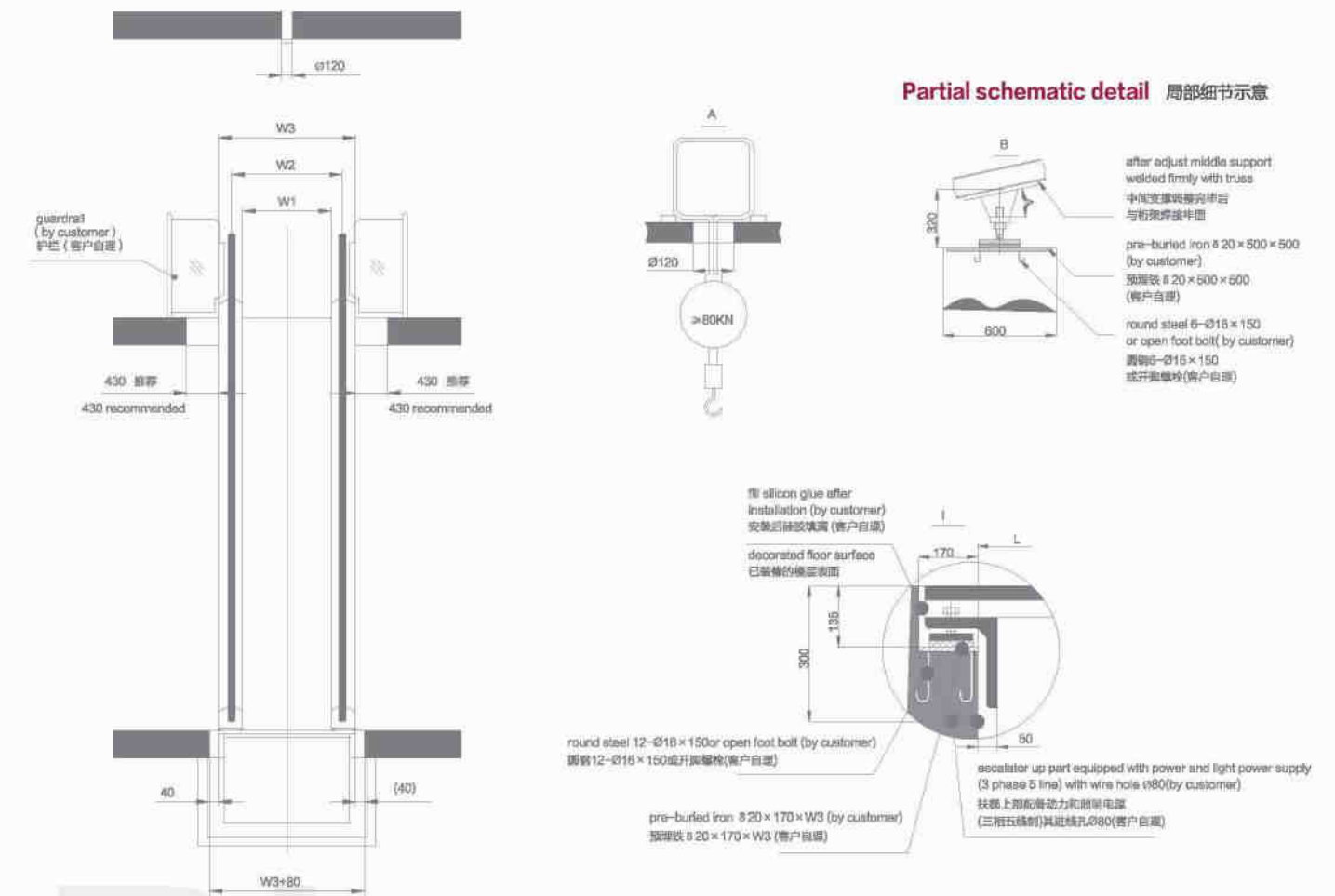
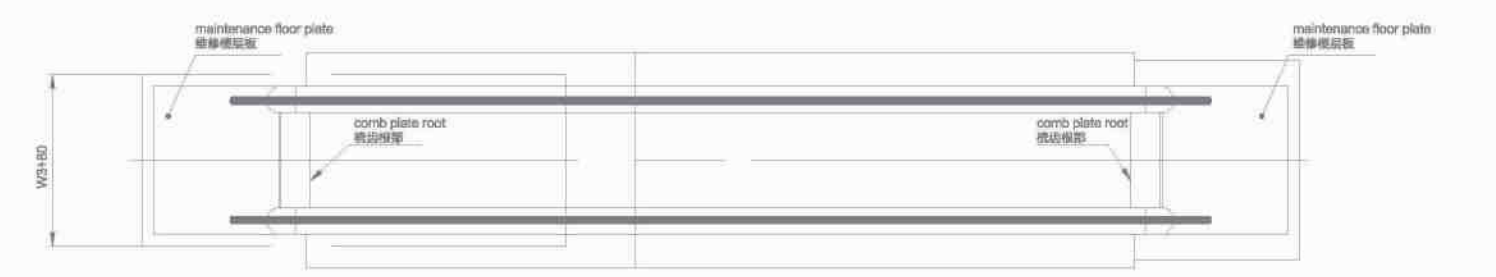
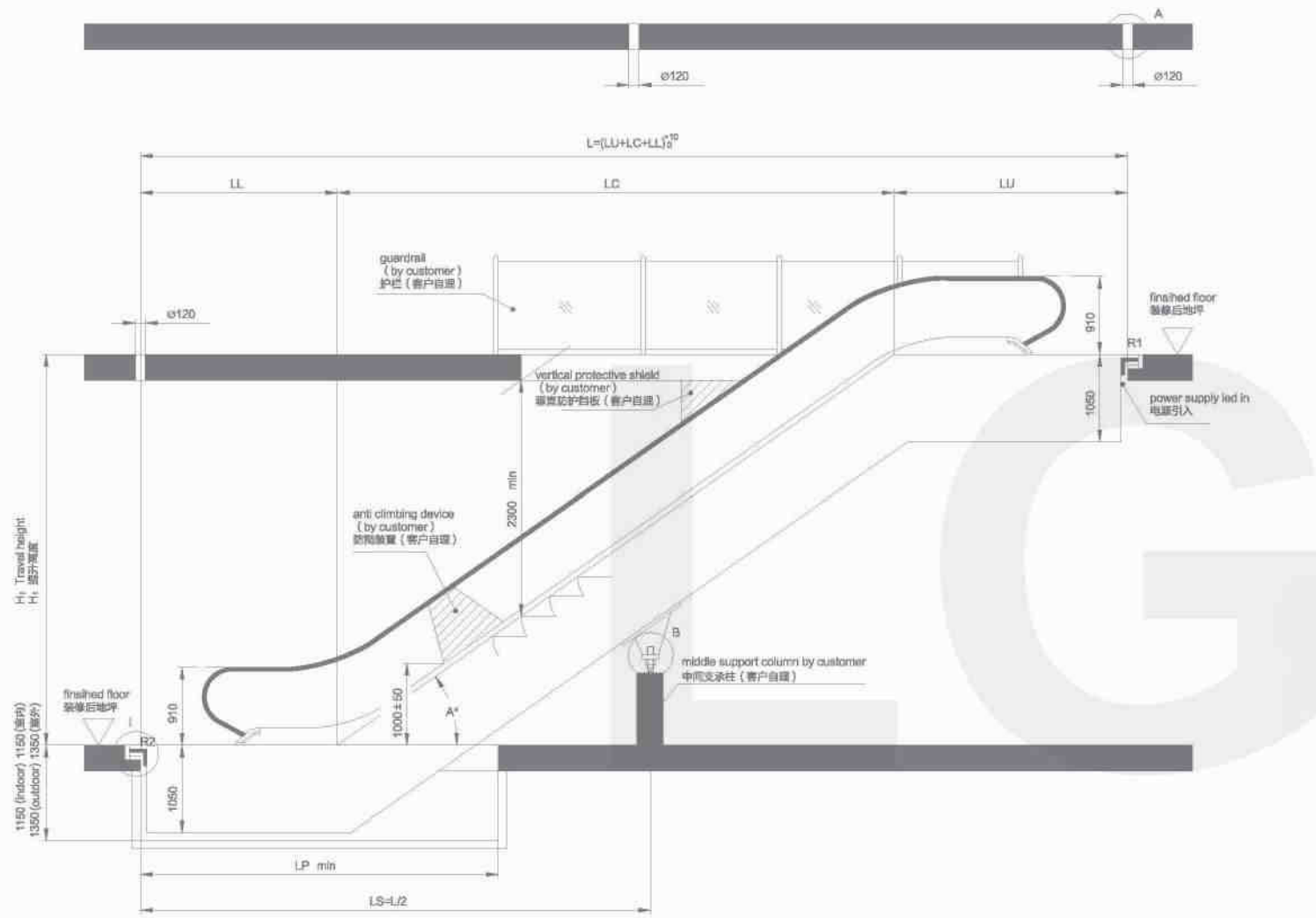

Degree A (°)	Supports number	Rated width W1 (mm)	Support force R1 (kN)	Support force R2 (kN)	Support force RM1 (kN)
倾斜角度 A (°)	支撑点数量	名义宽度 W1 (mm)	支持力 R1 (kN)	支持力 R2 (kN)	支持力 RM1 (kN)
35	2	600	3.28 × L + 7	3.28 × L + 2	—
		800	3.98 × L + 9	3.98 × L + 3	—
		1000	4.68 × L + 13	4.68 × L + 5	—
30	2	600	3.24 × L + 14	3.24 × L + 8	—
		800	3.82 × L + 17	3.82 × L + 11	—
	3	800	1.91 × L + 12	1.91 × L + 7	3.82 × L + 9
		1000	2.2 × L + 16	2.2 × L + 8	4.4 × L + 10

Degree A (°)	Flat step	LL (mm)	LC (mm)	LU (mm)	Rated width W1 (mm)	Handrail center distance W2 (mm)	Escalator out width W3 (mm)	Pit length LP (mm)
倾斜角度 A (°)	平梯级数	(mm)	(mm)	(mm)	名义宽度 W1 (mm)	扶手中心距 W2 (mm)	扶梯外宽 W3 (mm)	底坑长度 LP (mm)
35	2	2275	1.428 × H	2550	1000	1237	1540	4100
					800	1037	1340	
					600	837	1140	
30	2	2245	1.732 × H	2485	1000	1237	1540	4300
					800	1037	1340	
					600	837	1140	
30	3	2645	1.732 × H	3177	1000	1237	1540	4700
					800	1037	1340	
					600	837	1140	

When the step width is 600mm, LU=417mm.
当梯级宽度为600mm时, LU=417mm.

Note: this drawing is not made in scale, above parameter is only for reference. Construction refers to confirmed contract.
备注: 此图不按比例绘, 以上数据仅供参考, 土建施工应以合同土建图为准。

CONSTRUCTION LAYOUT DRAWING

E1300 Public Escalator

E1300 公交型自动扶梯土建参数

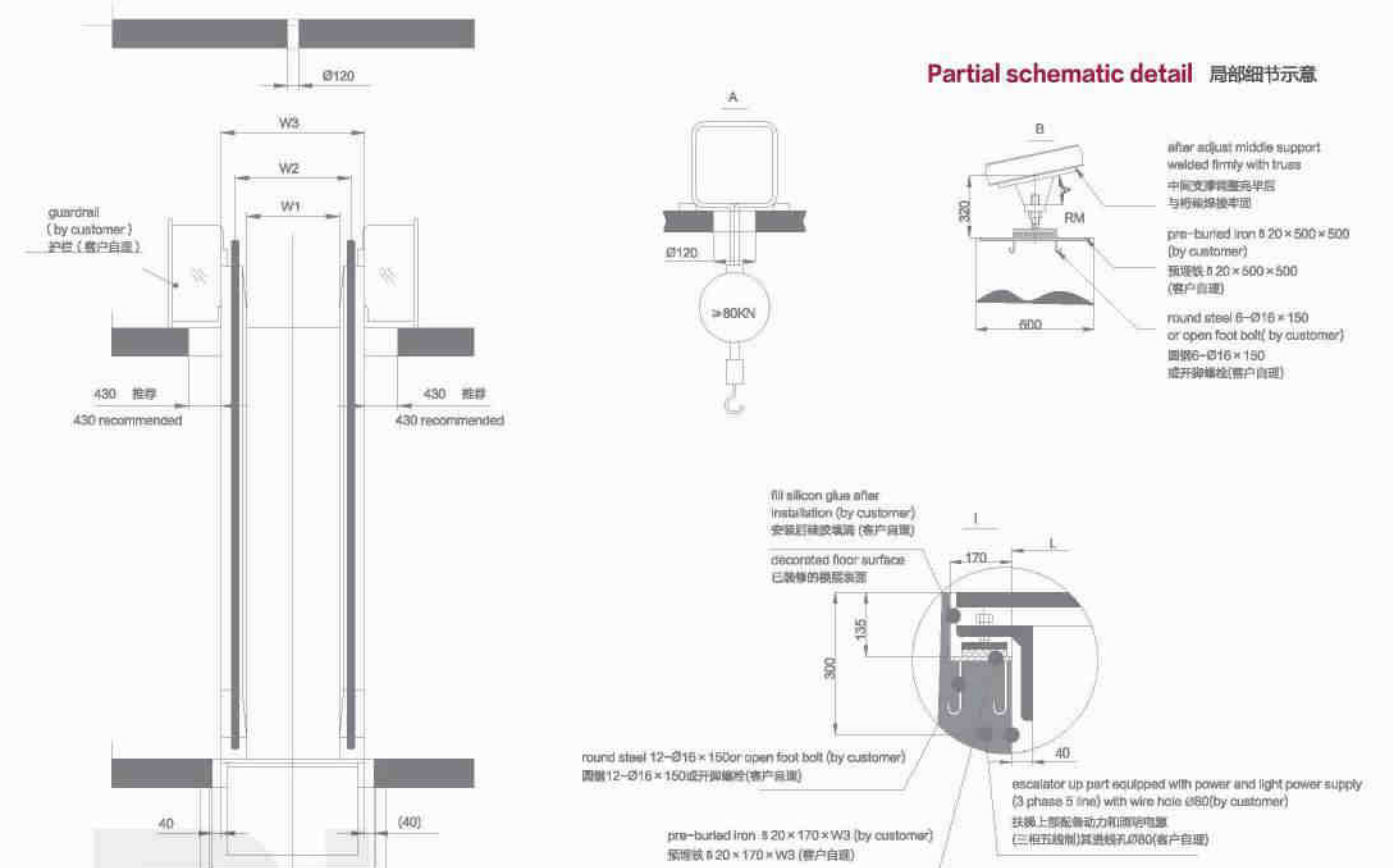
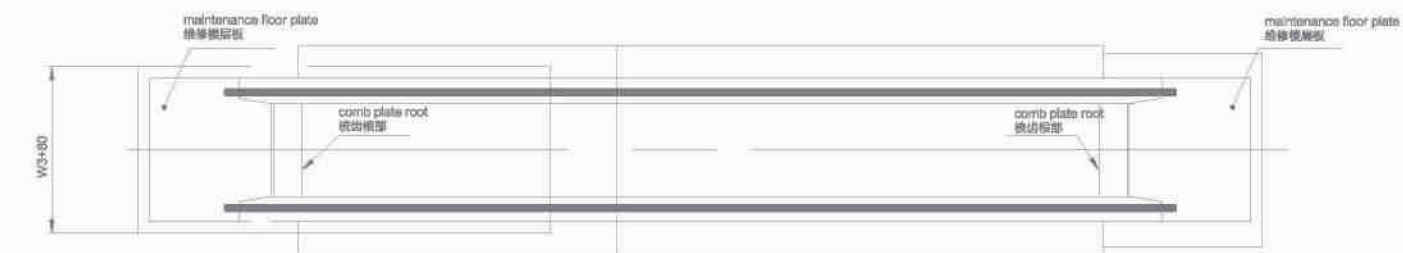
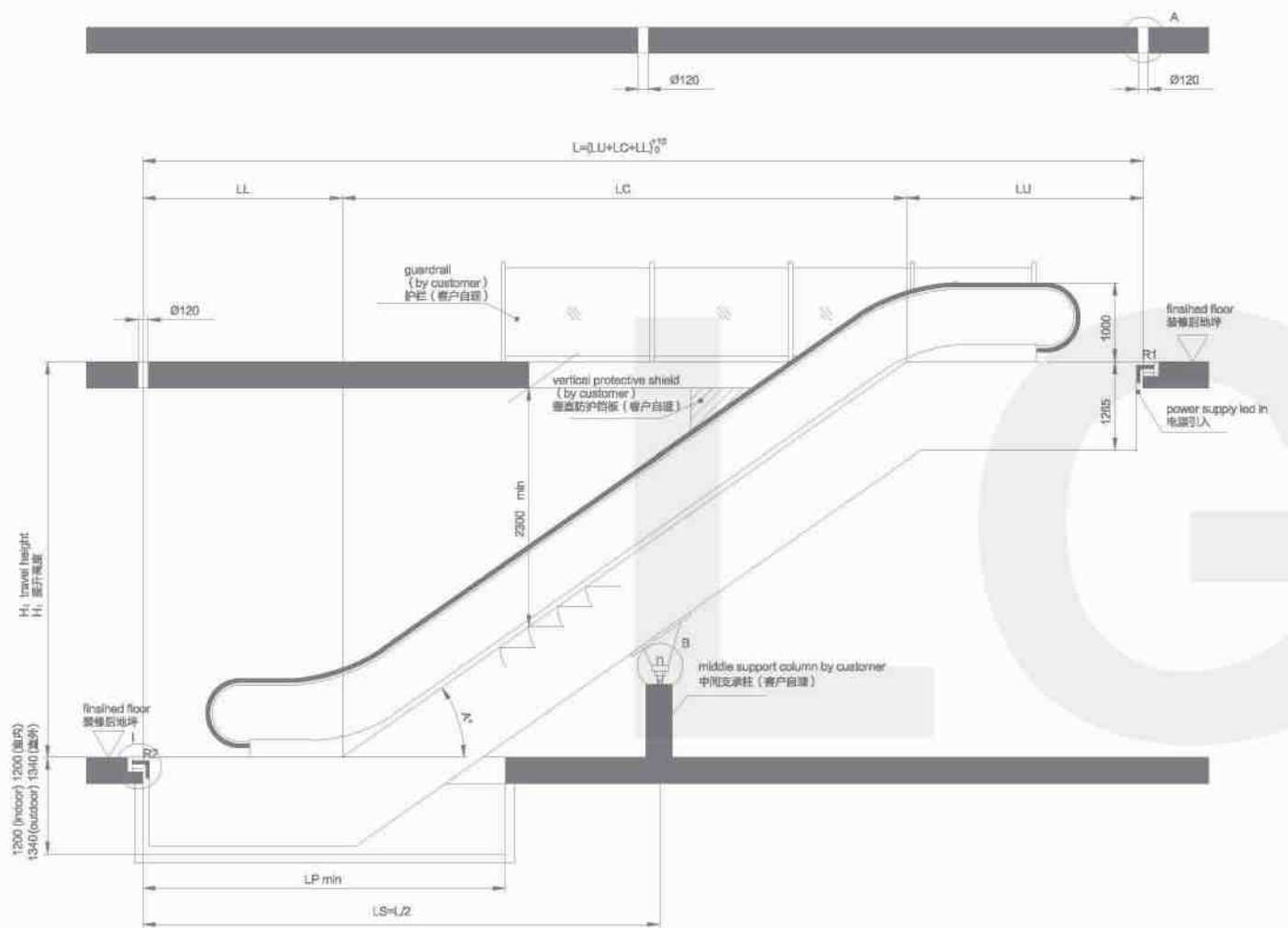

Degree A (°)	Supports number	Rated width W1	Support force R1 (kN)	Support force R2 (kN)	Support force RM1 (kN)	Support force RM2 (kN)
倾斜角度 A (°)	支撑点数量	名义宽度 W1 (mm)	支持力R1 (kN) L: (m)	支持力R2 (kN) L: (m)	支持力RM1 (kN) L: (m)	支持力RM2 (kN) L: (m)
30	4	800	1.4*L+23	1.4*L+3	3.8*L+15	3.8*L+15
		1000	1.5*L+23	1.5*L+3	4*L+15	4*L+15
	3	800	1.7*L+23	1.7*L+3	5.7*L+15	—
		1000	1.9*L+23	1.9*L+3	6.5*L+15	—
	2	800	4.6*L+22	4.6*L+7	—	—
		1000	5*L+22	5*L+7	—	—

Degree A (°)	Flat step	LL	LC	LU*	Rated width W1	Handrail center distance W2	Escalator out width W3	Pit length LP
倾斜角度 A (°)	平梯级数	(mm)	(mm)	(mm)	名义宽度 W1 (mm)	扶手中心距 W2 (mm)	扶梯外宽 W3 (mm)	底坑长度 LP (mm)
30	3	2688	1.732 * H	3537	1000	1237	1590	4900
					800	1037	1390	
27.3		2597	1.938 * H	3608	1000	1237	1590	5000
					800	1037	1390	
23.2		2520	2.333 * H	3686	1000	1237	1590	5400
					800	1037	1390	

Note: this drawing is not made in scale, above parameter is only for reference. Construction refers to confirmed contract.

* when choose double motor, LU increase 50mm

备注: 此图不按比例绘制, 以上数据仅供参考, 土建施工应以合同土建参数为准 *选择双主机时, LU增加50mm.

CONSTRUCTION LAYOUT DRAWING

E191 Waving Escalator

E191波浪型自动扶梯土建参数

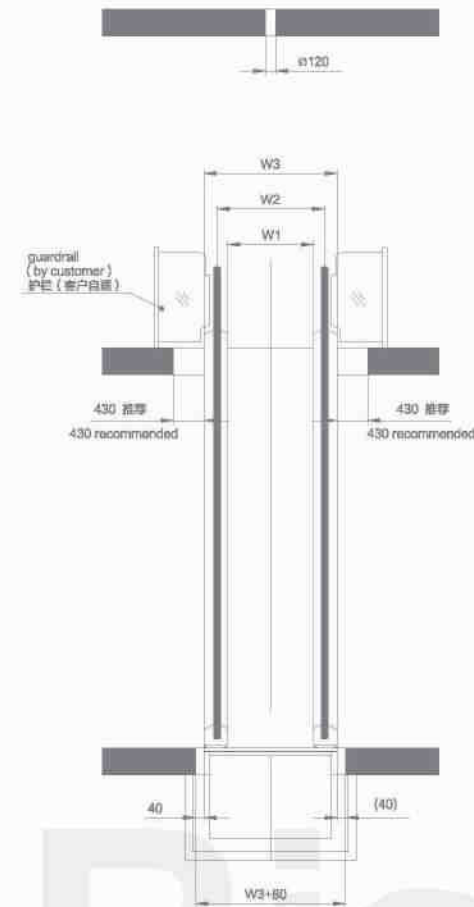
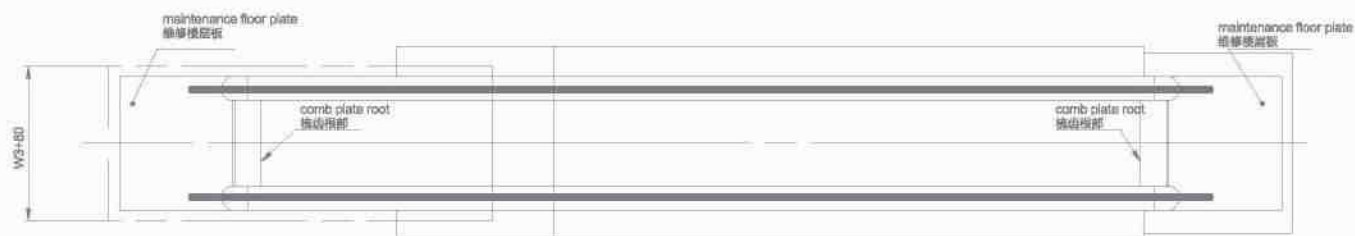
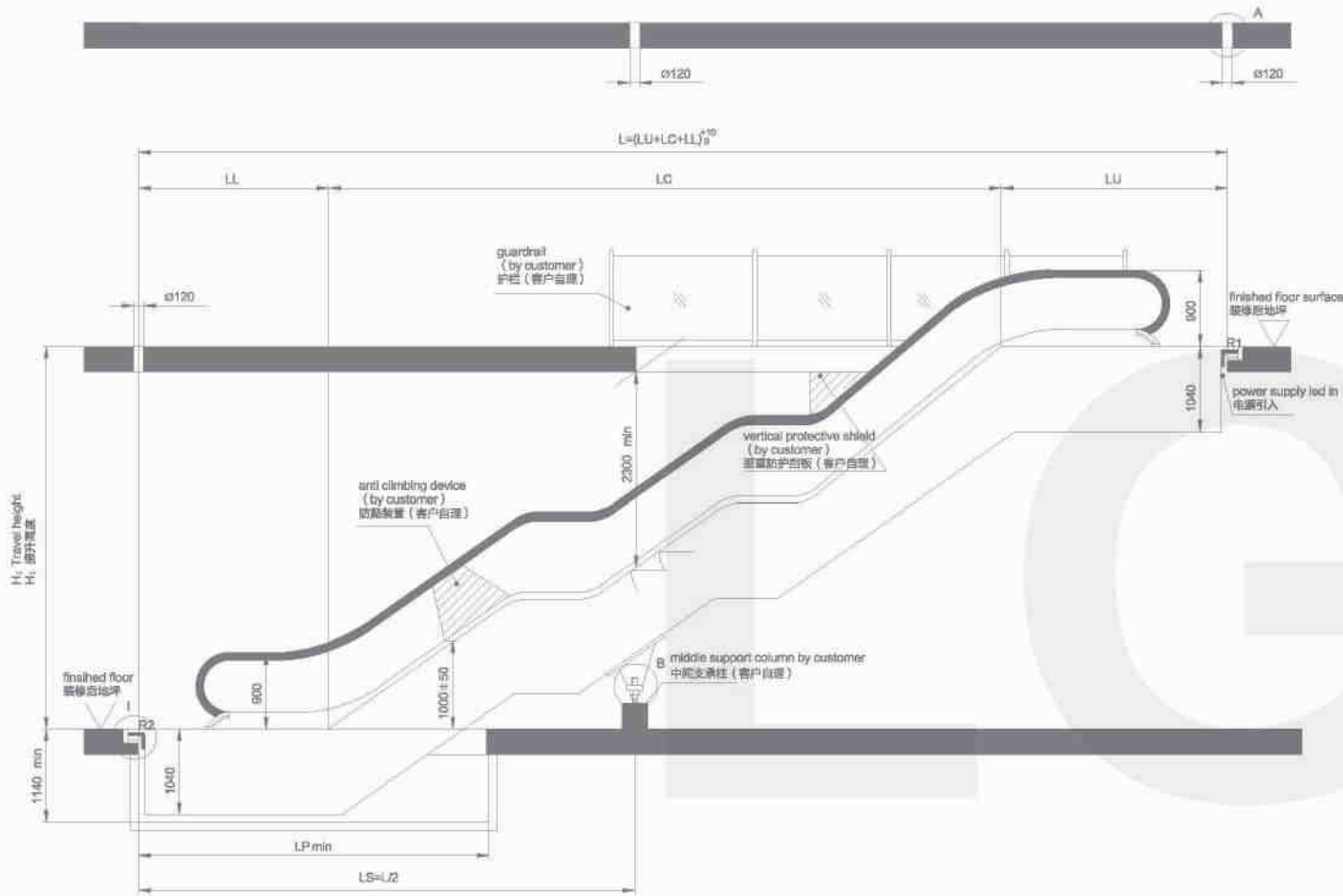

Partial schematic detail 局部细节示意

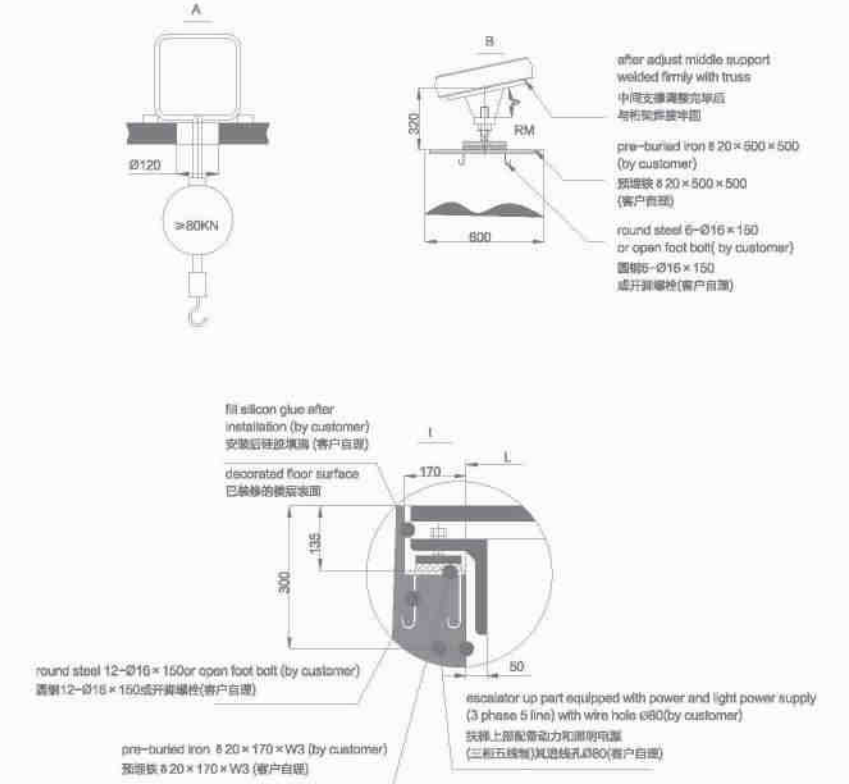

Degree A (°)	Flat step	LC	LL
倾斜角度 A (°)	平梯级数	(mm)	(mm)
30	two flat step 二级平梯	1,732 × H + 2935	2239
35		1,428 × H + 2935	2273

LU	Rated width W1	Handrail center distance W2	Escalator out width W3	Pit length LP
(mm)	名义宽度 W1 (mm)	扶手中心距 W2 (mm)	扶梯外宽 W3 (mm)	总坑长度 LP (mm)
2492	1000	1237	1540	4400
	800	1037	1340	
	600	837	1140	
2552	1000	1237	1540	4200
	800	1037	1340	
	600	837	1140	

Note: this drawing is not made in scale, above parameter is only for reference. Construction refers to confirmed contract.

备注: 此图不成比例绘制, 以上数据仅供参考, 土建施工应以合同土建图为准



MOVING SIDEWALK

自动人行道

In the public transport places and in the colorful modern cities, including large-scale supermarkets, public buildings, airports, exhibition centers and transport switching stations, our moving sidewalks can not only meet the transportation issues with huge visitors flow rate, but also meet the long-distance working and carrying of luggage barrows, baby carriages, shopping carts and vehicles for disabilities and so on, to make people have comfortable feeling when going upstairs and downstairs during shopping, they bring much convenience for people moving and become a necessary transportation solution for these places.

Our moving sidewalks have elegant appearance as well as extremely great fashionable and pretty styles. They can be harmoniously integrated with the modern architecture and interior decoration, to perfectly render the design philosophy of advanced technology, safety, reliability, electricity saving, energy conservation, stability and comfort.

在缤纷的现代都市、大型超市、公共建筑物、机场、展览中心及运输转换站等公共交通运输场合，自动人行道因其产品自身的特点，不仅能满足人流量巨大的运输问题，也能满足长距离步行和运送行李车、婴儿车、购物车、残疾车等，使人们在乘坐的时候特别是在购物之际上楼下楼有如履平地的感觉，极大地方便了人们的出行和购物。由此也成为各大超市、机场、展览中心及运输转换站的首选解决方案。

我们的自动人行道外形豪华气派，极具时尚美感，能和大都市现代建筑和室内装饰和谐融合，完美地诠释了技术先进、安全可靠、省电能、平稳舒适的设计理念。

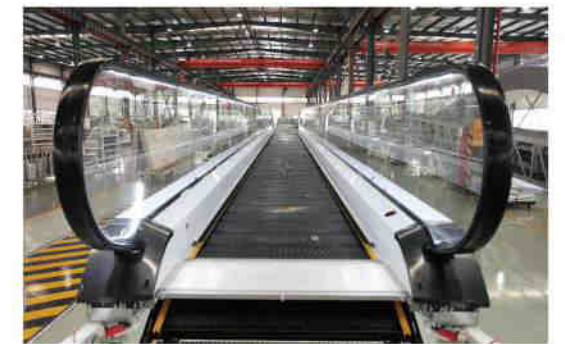

CONSTRUCTION LAYOUT DRAWING

E1600 Moving Walks

E1600水平型自动人行道土建参数

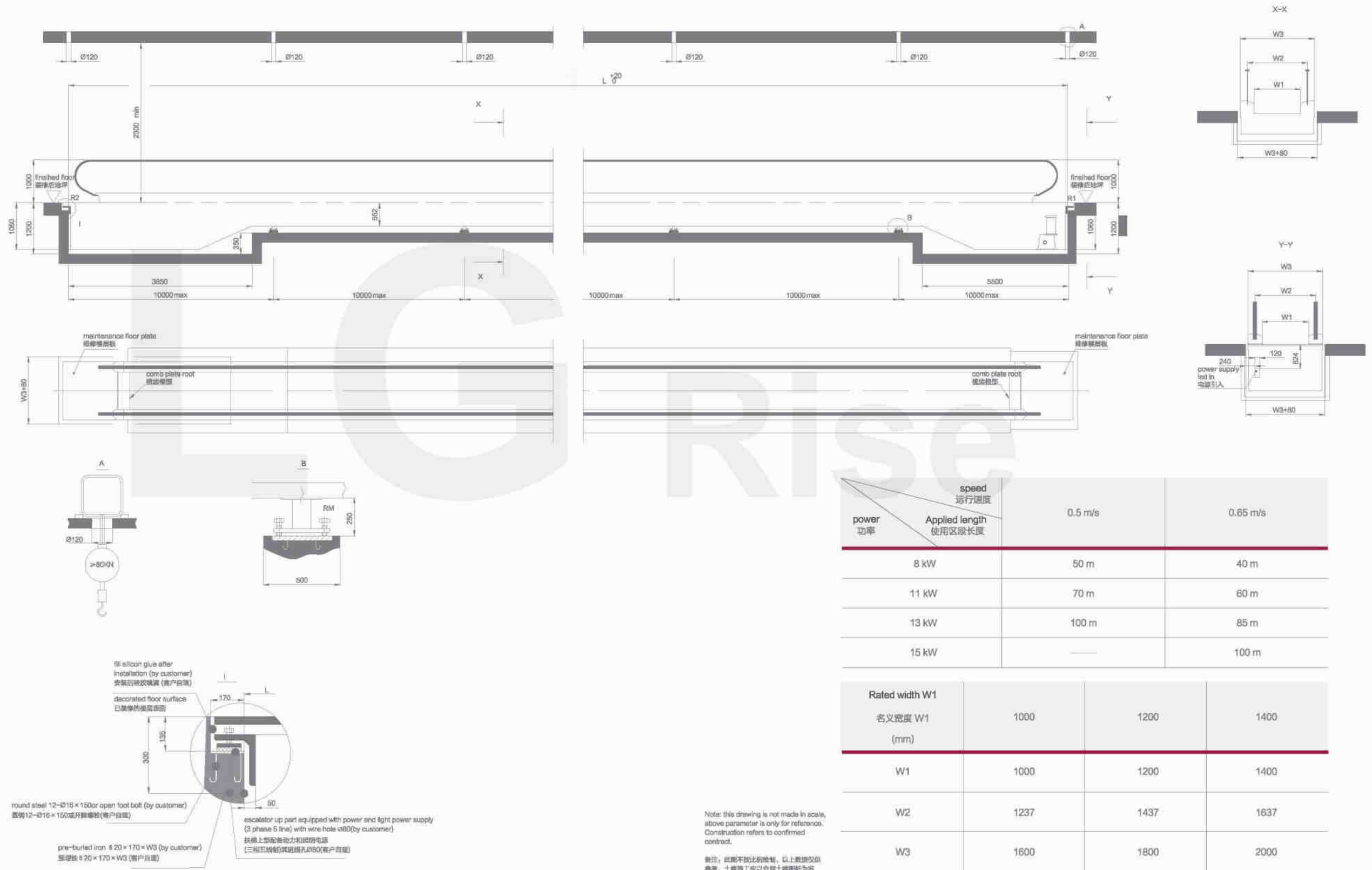

CONSTRUCTION LAYOUT DRAWING

E1500 Moving Walks

E1500倾斜型自动人行道土建参数

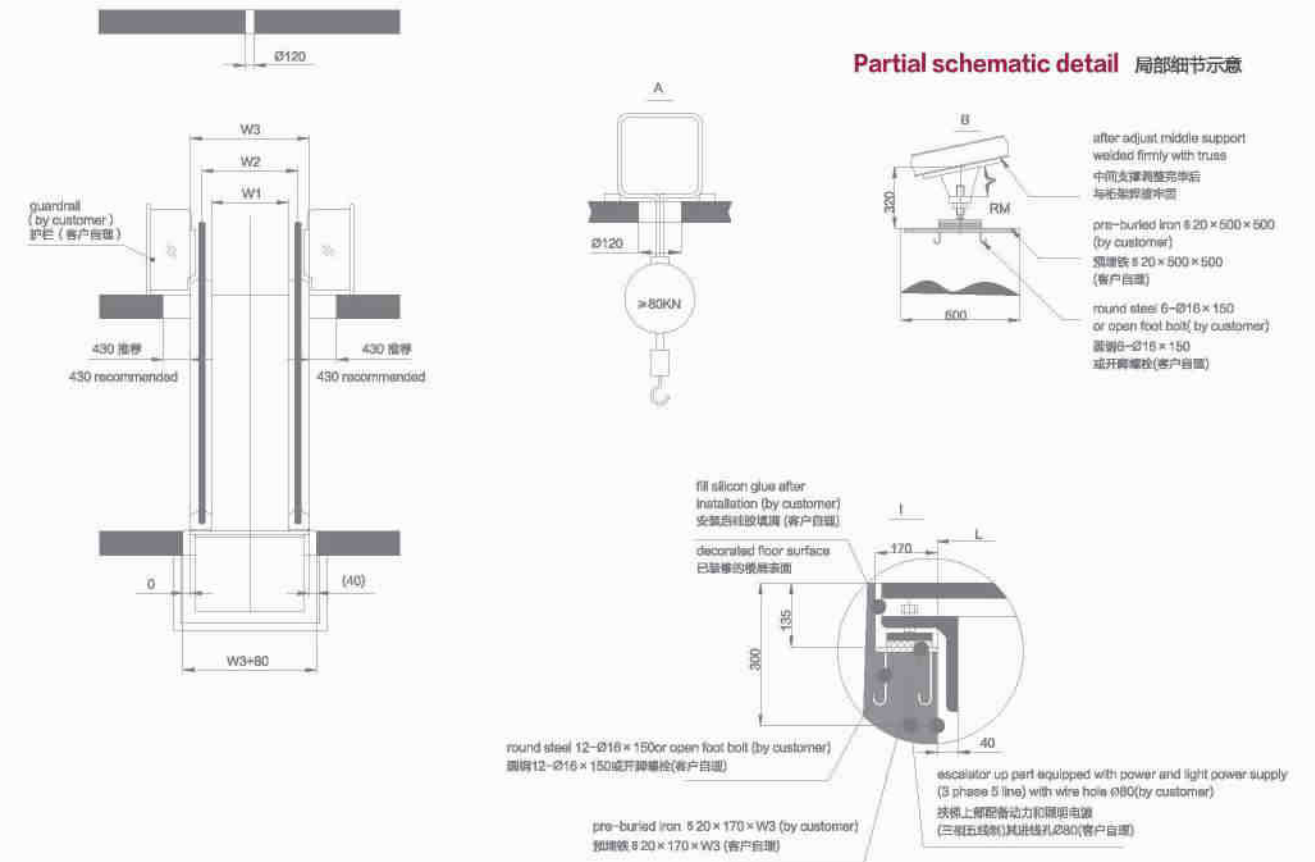
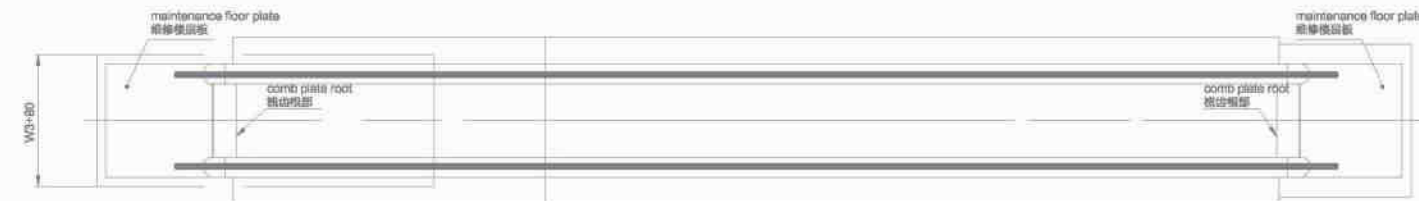
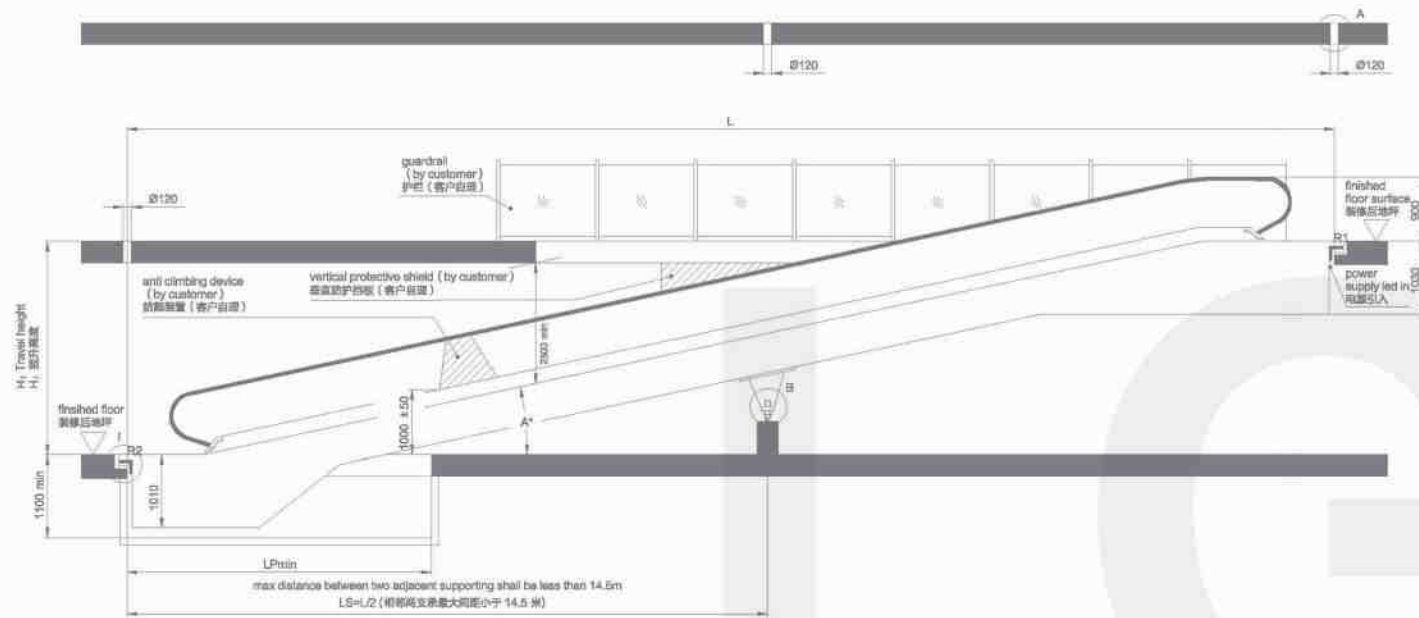

Supports number 支撑点数量	Rated width W1 名义宽度 W1 (mm)	Support force R1(KN) 支持力R1(KN) L: (m)	Support force R2(KN) 支持力R2(KN) L: (m)	Support force RM1(KN) 支持力RM1(KN) L: (m)	Support force RM2(KN) 支持力RM2(KN) L: (m)
4	800	1.3 × L + 19	1.3 × L + 11	3.1 × L + 10	3.1 × L + 11
	1000	1.5 × L + 16	1.5 × L + 8	3.45 × L + 6	3.45 × L + 7
3	800	1.9 × L + 19	1.9 × L + 11	5.2 × L + 10	—
	1000	2.2 × L + 16	2.2 × L + 8	6.1 × L + 6	—
2	800	4.25 × L + 19	4.25 × L + 11	—	—
	1000	4.9 × L + 16	4.9 × L + 8	—	—

Degree A (°) 倾斜角度 A (°)	L (mm)	Rated width W1 名义宽度 W1 (mm)	Handrail center distance W2 扶手中心距 W2 (mm)	Handrail center distance W3 扶梯外宽 W3 (mm)	Pit length LP 底坑长度 LP (mm)
10	5.6713 × (H + 16.7) + 2900	1000	1237	1540	4800
		800	1037	1340	
11	5.1446 × H + 2900	1000	1237	1540	4500
		800	1037	1340	
12	4.7046 × (H - 16.7) + 2900	1000	1237	1540	4300
		800	1037	1340	

Note: this drawing is not made in scale, above parameter is only for reference. Construction refers to confirmed contract.

备注：此图不按比例绘制，以上数据仅供参考，土建施工应以合同土建图为准。